

airgle®  
Precisely Pure

# Owner's Manual

Airgle® Personal Air Purifier ( Model: AG25 )





## WARNING

### Important safety instructions

### READ AND SAVE THESE INSTRUCTIONS

Read all instructions before using this air cleaner:

- Before turning on the power, please check carefully whether the machine is equipped with all configurative filters, make sure the local voltage used for the cleaner meets the rated voltage specified on the data plate at the bottom of the machine. Make sure the AC/DC power adaptor is plugged into a live 100-240V AC outlet when using it in an office or home, make sure the cigarette lighter power adaptor is plugged into a 12V DC outlet when using it in a car .
- Maintain the low air flow in the car and keep windows closed.
- Do not touch the machine with sharp objects to avoid damages or scratches.
- Do not disassemble or remove any part of the unit except replacing the filters.
- Children should be supervised to ensure that they do not play with the appliance, in order to avoid unnecessary personal injury. Cleaning and user maintenance shall not be made by children without supervision.
- Do not insert any objects into the machine, it may damage the internal precision components.
- When replacing the filters or cleaning the surface of the purifier, please unplug the power plug from the socket and wipe it with a soft cloth.
- Do not use parts or filters not recommended by Airgle®.
- Do not attempt to operate the purifier while driving. Please stop the car at a safety area first if you need to.
- Do not attempt to repair the air purifier if the machine is found to be damaged. Stop using it immediately and send it to the designated after-sales service center for repair.
- Do not expose the machine to liquid, moisture, or a wet place.
- Do not expose the machine to heating devices, gas, inflammable and explosive materials, or even open flames.
- Do not break, bend, or twist the power cable to avoid the risk of fire and electric shock due to damage.
- When replacing the filters or cleaning the surface of the purifier, be sure to hold the housing of AC/DC power adaptor with a dry hand first to unplug it; and then perform subsequent operations.
- This appliance can be used by children aged from 8 years and above, and persons with reduced physical, sensory or mental capabilities, or lack of experience and knowledge, if they have been given supervision or instruction concerning use of the appliance in a safe manner and understand the hazards involved.
- This appliance contains a UV-C emitter. Unintended use of the appliance or damage to the housing may result in the escape of dangerous UV-C radiation. UV-C radiation may, even in small doses, cause harm to the eyes and skin.



## CONTENTS

WARNING: IMPORTANT SAFETY INSTRUCTIONS -----	1
THE AIRGLE® AG25 PERSONAL AIR PURIFIER -----	3
UNPACKING -----	4
INSTALLATION -----	5
OPERATION -----	7
HOW AIRGLE® PERSONAL AIR PURIFIER WORKS -----	8
HOW TO REPLACE THE FILTERS -----	9
WARRANTY -----	10



## THE AIRGLE® AG25 PERSONAL AIR PURIFIER

The Airgle® Personal Air Purifier (AG25) is a great pick for those that are looking for something stylish that can handle all small particles, VOCs, odors, bacteria and viruses, and allergens in their office and car environments. The Airgle® AG25 is equipped with cHEPA, carbon and PCO technologies used to remove 99% of all air contaminants. The AG25 model features Airgle® AutoCleaning technology that cleans the air before you walk into your personal office area or get into your car.

- Captures up to 99.999% of allergens with true cHEPA filtration including: Dust mites, smoke, pet dander, plant pollens and more.
- Removes up to 99% of formaldehyde and VOCs and odor with premium activated carbon.
- Kills up to 99% of bacteria and viruses with US patented PCO technology - Titanium Pro® Module.
- Easy to replace filter by simply pushing the side filter drawer.
- One button operation.
- Smart filter life indicator.
- Low voltage protection for car batteries; the product will be automatically shut off when battery voltage is lower than 12V.
- Automatically Activate Operation even when a car engine is off, providing refreshing air when you get into the car the next morning!
- Airgle® Smart Temperature Protection Technology.
- Installation: Back of seat and office desktop.

### Titanium Pro® Module

The AG25 Airgle® Personal Air Purifier comes with a Titanium Pro® UV module. This module is considered the next generation of photocatalytic oxidation technology, and is the first Titanium Pro® module in the world successfully developed by the Airgle team after many years of research. The module is configured with all the components for air purification through the oxidation effect of photocatalysts and UV light.

The catalytic area in the module can effectively kill bacteria and viruses, as well as safely break down harmful chemical gases and odors.

The working principle of the Titanium Pro® UV module: This Titanium Pro® UV module surface is coated with a photocatalyst. It degrades air pollutants by exposing both the pollutants and the catalyst to the photons of UV light. The pollutants are rapidly converted into harmless substances when the UV light energy activates the catalyst.

Our patented Titanium Pro® includes the following features:

- Unique structure design to allow maximum airflow, rapidly diluting the concentration of unwanted airborne contaminants.
- UVC lamp.
- Plug and play technology.
- Works at room temperature.
- No chemical additives.
- No residual ozone.
- High oxidation yields for gas phase reactants and odors.
- Low energy requirements.
- Works in humid conditions.
- Long service life.

## Technical Parameters

Clean Air CADR:	9 cfm
TVOC Removal Performance:	>99%
Formaldehyde Removal Performance:	>99%
Bacteria Removal Performance:	>99%
Noise:	42~55 dB(A)
Voltage:	DC 13.5 V
Recommended Use Environment:	Cars, SUVs and Personal Office Areas
Product Size:	L9.5*9.5*2.76 Inch



## UNPACKING

Unpack your Airgle® Personal Air Purifier as follows:

1. Remove the Airgle® Personal Air Purifier from the packaging.
2. Do not throw the original box and packaging away. Keep it in case you need to transport the unit again sometime in the future.
3. Check the components received against your packing slip to make sure you have all the parts.
4. Check the unit and all the components for damage. If the unit or any of the components show damage from shipping, contact your local dealer.
5. For your future convenience, record the model information here. Model information can be found on the name plate located on the bottom of your unit.

Model Number:	Purchase Date:	QR Code:

### Component List:

- 1) Main device (1 piece);
- 2) AC/DC power adaptor (1 piece);
- 3) Cigarette lighter power adaptor (1 piece);
- 4) Owner's manual (1 piece);
- 5) Car installation accessories (4 mounting kits, 4 screws and 1 screwdriver);
- 6) Packing box (Styroform inside) (1 piece);



## INSTALLATION

Now that you have unpacked your Personal Air Purifier, where are you going to use it?

### Installation Position 1: Place on an office desktop

- 1) Place the product directly on the office desktop and connect the AC/DC power adaptor to a 100-240V power outlet.
- 2) As shown in the figure, you can also use machine holder (it is optional, not included) for Airgle® Personal Air Purifier.

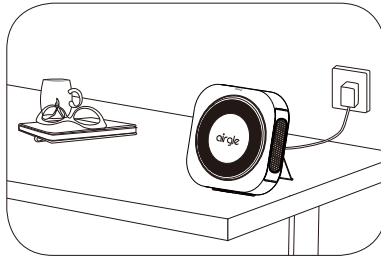

### Installation Position 2: Back of seat

- 1) As shown in Figure 1, plug the connector of the cigarette lighter power adaptor into the purifier bottom.
- 2) Plug the cigarette lighter power adaptor head to a 12V DC power socket as in Figure 2.
- 3) Adjust the length of the car seat mounting strap to the same size as the seat and fasten the seat buckle.

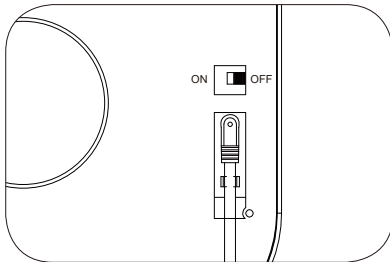

Figure 1

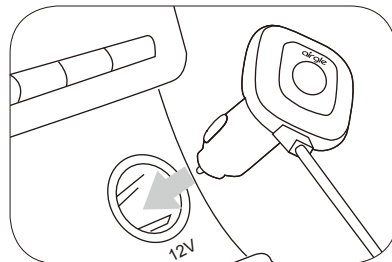

Figure 2

- 4) Fasten the headrest mounting strap onto the device bottom through 4 screws as shown in Figure 3.
- 5) As shown in Figure 4, you can install the Airgle® Personal Air Purifier behind the seat.

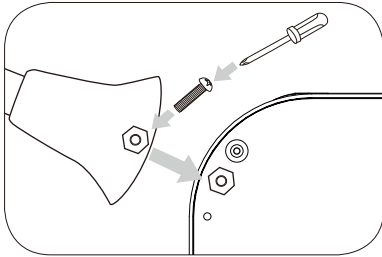

Figure 3

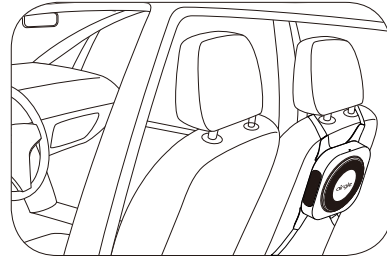

Figure 4

### Advanced Installation: Car wiring installation

Your Airgle® system provides Automatically Activated Operation design. It can automatically activate operation even when a car engine is off, providing refreshing air when you get into the car the next morning!

- 1) You can install the Airgle® Personal Air Purifier behind the seat in the car. Adjust the length of the car seat mounting strap to the same size as the seat and fasten the seat buckle.
- 2) Cut off the head of the cigarette lighter power adaptor, connect its wiring onto the car battery.

Note: You need to have an authorized auto dealer to connect the power cord directly to the car's internal battery (12VDC). Make sure a 5A fuse is connected. Airgle is not responsible for any mistakes made by the end user.

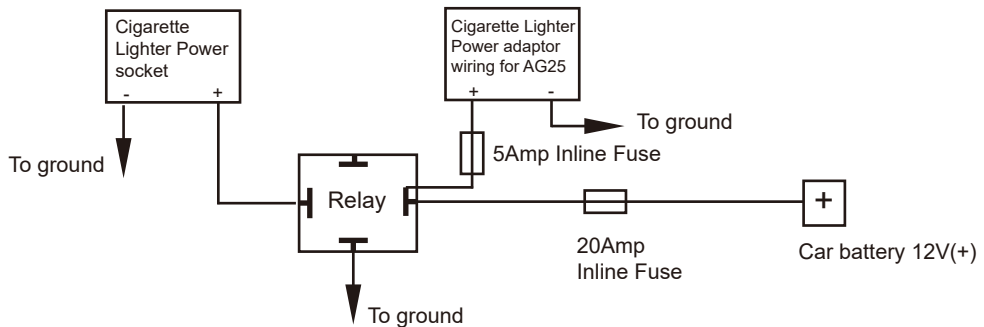

Note: The power connector can only be installed on a 12V cigarette lighter; it must be installed by an authorized dealer.



## OPERATION

### Power on

When the power is turned on, the purifier indicator is on, and the machine will automatically run in the low speed mode.

### Power off

Slide the switch to the opposite side to turn off the power. The indicator light of the purifier is off and the machine is powered off.

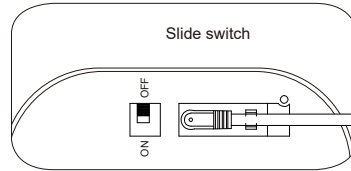
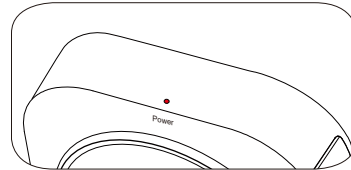

## One button operation control technology

The machine has three modes: High-speed, standby, and low-speed. Touching the “Power” button will adjust the mode in the order of high-speed, standby, and low-speed, while the machine will simultaneously generate a “Ding” sound alert.

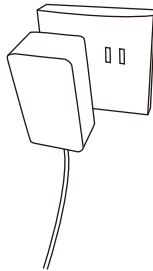

## Filter replacement

When filter life indicator is blinking, it means the filter needs to be replaced. Detailed replacement method is shown on page 9.





## HOW AIRGLE® PERSONAL AIR PURIFIER WORKS

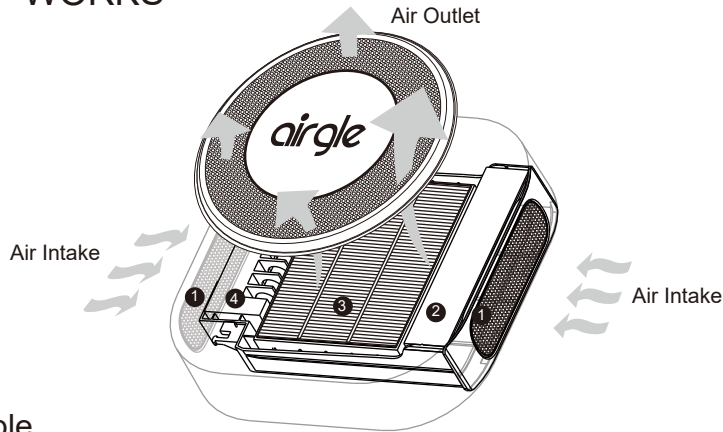

### Working principle

The air enters through the right and left air inlets simultaneously and is rapidly purified. The air, which enters through the right air inlet, passes through pre-filter and carbon filter. The air through the left air inlet is purified through Airgle® Titanium Pro® Module. The air inside the machine is then filtered and purified through cHEPA filter. Lastly, the filtered and clean air is blown out from the top of the machine.

- 1) Pre-filter: Used to filter larger particles such as hair or animal dander.
- 2) Carbon filter: Absorbs harmful gaseous pollutants, removes odor, and purifies formaldehyde.
- 3) cHEPA filter: Cleans and removes 0.003 microns contaminants
- 4) Airgle® Titanium Pro® module: Under the photocatalytic action of UV light, it can effectively degrade formaldehyde, volatile organic compounds (TVOC) and other pollutants, and it kills bacteria and viruses, therefore purifying the air and making the air's health index more favorable to breathe.

### Airgle® smart temperature protection technology

Automatically shut off the UV lamp if the car's interior temperature is over heated, and it will be turned on when the temperature drops down to normal.

### Airgle® AutoCleaning technology

Airgle® Personal Air Purifier provides Automatically Activate Operation even when a car engine is off, providing refreshing air when you get into the car the next morning! (This function is suitable for advanced installation mode of the machine).



## HOW TO REPLACE THE FILTER?

### Smart filter life indicator

Blinking: When the red light blinks, it reminds us that we need to replace the filters.

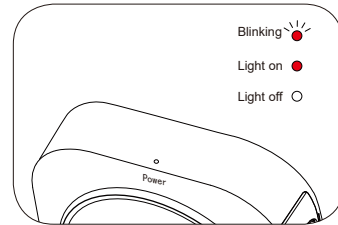

### Filter removal

Your Airgle® system provides Easy-Change Filter Design. Always turn off the air purifier and unplug the cigarette lighter power adaptor or AC/DC power adaptor when performing any cleaning or maintenance tasks. As shown in Figures 1&2, press Side Filter Drawer and it will pop up. Take it out according to its pop-up direction, then remove the carbon filter, cHEPA filter or Titanium Pro® UV module.

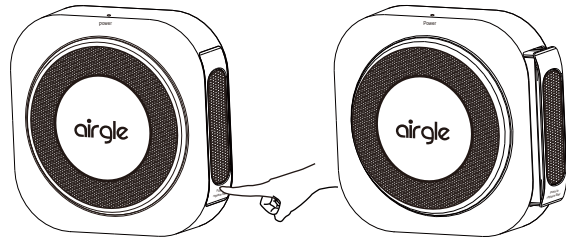

Figure 1

### Replacing filters

Replace the Titanium Pro® UV module, carbon filter, and cHEPA filter, reinstall the Side Filter Drawer back into the machine, then turn on the power and keep touching the "Power" button for 3 seconds until you hear two "Ding" sounds, the filter life is reset successfully and the machine resumes normal operation. Make sure the drawer is completely closed.

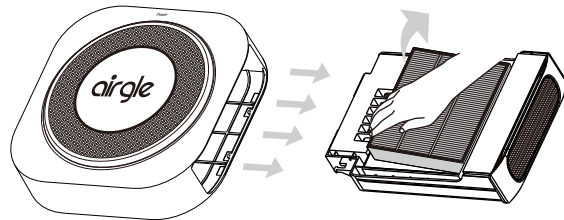

Figure 2



### WARRANTY TIPS:

Airgle Corporation offers a One Year Limited Warranty on Airgle® Personal Air Purifier. To activate your warranty, please visit us on the web at [www.airgle.com](http://www.airgle.com) and register the serial number and model number of your new Airgle products, as well as your contact information.



### ENVIRONMENT-FRIENDLY DISPOSAL

You can help protect the environment!  
Please remember to respect the local regulations: Hand in the non-working electrical equipment to an appropriate waste disposal center.

airgle®

Precisely Pure

AIRGLE CUSTOMER CARE

☎ (866) 501-7750

@ info@airgle.com

www.airgle.com