

User manual

Vacuclave[®] 118 Vacuclave[®] 123

Steam sterilizer

from software version 2.3.1



EN

Dear customer,

We thank you for your confidence demonstrated by the purchase of this MELAG product. As an owner-run and operated family concern founded in 1951, we have a long history of successful specialization in hygiene products for practice-based use. Our focus on innovation, quality and the highest standards of operational reliability has established MELAG as the world's leading manufacturer in the instrument reprocessing and hygiene field.

You, our customer are justified in your demand for the best products, quality and reliability. Providing **“competence in hygiene”** and **“Quality – made in Germany”**, we guarantee that these demands will be met. Our certified quality management system is subject to close monitoring: one instrument to this end is our annual multi-day audit conducted in accordance with EN ISO 13485. This guarantees that all MELAG products are manufactured and tested in accordance with strict quality criteria.

The MELAG management and team.

CE 0197

Contents

1 General guidelines	6
Symbols used	6
Formatting rules	6
Disposal	6
2 Safety	7
3 Performance specifications	8
Intended use	8
Sterilization procedure	8
Type of the feed water supply	8
Program runs	9
Safety equipment	10
Performance characteristics of sterilization programs	10
4 Description of the device	11
Scope of delivery	11
Views of the device	12
Symbols on the device	13
Touch display	15
LED display and acoustic signals	17
Load mount	18
5 Installation requirements	19
Installation location	19
Electromagnetic environments	19
Space requirements	20
Mains connection	21
Water connection	21
System and network safety	22
Operating the device with memory media	23
Operating the device in the local network (LAN)	23
Network bandwidth / Quality of Service (QoS)	23
6 Setup and installation	24
Removing from the packaging	24
Use of a water treatment unit	25
Installation examples	26
Example 1 - Manual water supply and disposal via internal storage tanks (as-delivered condition)	26
Example 2 - Automatic water supply and disposal with MELAdem 40 ion exchanger	27
Example 3 - Automatic water supply and disposal with MELAdem 47 reverse osmosis unit	29
Aligning the device	31
Electrical test in accordance with EN 50678 (VDE 0701) or national standard	31
Connecting the mains cable and removing accessories	32
Checking the software version	32
Checking water supply and disposal	32
Checking date and time	32
Setting the display	33

Test runs	33
Instructing the users	33
Record of installation and setup	33
7 First steps	34
Switching on the device	34
Opening and closing the door	34
Opening the door	35
Close the door	35
Manual door emergency-opening	36
Feed water supply	37
Using the feed water tank	37
Disposal of the wastewater	38
8 Important information for routine operation	39
9 Sterilization	40
Preparing the load	40
Reprocessing the instruments	40
Reprocessing textiles	40
Loading the steam sterilizer	41
Closed sterile containers	41
Soft sterilization packaging	42
Multiple wrapping	42
Mixed loads	42
Loading volumes	42
Selecting the program	43
Starting the program	44
Program options	45
Program in progress	45
Manual program abort	46
Ending the program prematurely	48
Program is ended	49
Removing the sterile material	50
Storing sterile material	51
10 Logging	52
Batch documentation	52
Logs menu	52
Subsequent log output	53
Output media	54
Displaying logs on the computer	55
11 Function checks	56
Service programs	56
Vacuum test	56
Steam penetration test	58
12 Settings	59
General settings	60
Language	60





Date.....	60
Time	61
Display	62
Audio	63
Energy saving	63
Dust filter	65
Log output	66
Water.....	70
Drying.....	71
Administrative settings	72
Logging on user role	72
Logging out as an administrator	73
Admin PIN	73
Network	74
Software update	76
13 Maintenance.....	77
Maintenance intervals.....	77
Cleaning.....	78
Sterilization chamber, door gasket, mount, trays	78
Housing parts	78
Internal storage tanks.....	79
Replace dust filter	81
Maintenance	82
14 Pause times	83
Duration of the operating pause	83
Decommissioning	83
Transport	83
Symbols on the packaging	83
On-site transport	84
Off-site transport	84
Fitting the carrying straps.....	84
Recommissioning after relocation	84
15 Malfunctions	85
Malfunction logs.....	86
Warning and malfunction messages.....	86
16 Technical data	91
17 Accessories and spare parts	93
18 Technical tables	95
Feed water quality	95
Nominal value tolerances	95
Empty chamber test.....	96
Pressure-time chart	96
Glossary	97

1 General guidelines



Please read this user manual carefully before commissioning the device. The manual includes important safety instructions. Make sure that you always have access to digital or printed version of the user manual.

Should the manual no longer be legible, is damaged or has been lost, you can download a new copy from MELAG download centre at www.melag.com.

Symbols used

Symbol	Explanation
	Indicates a dangerous situation, which if not avoided, could entail slight to life-threatening injuries.
	Draws your attention to a situation, which if not avoided, could result in damage to the instruments, the practice fittings or the device.
	Draws your attention to important information.
	Indicates the section in the document that contains content relevant for the service technician.

Formatting rules

Example	Explanation
see Chapter 2	Reference to another text section within this document.
Universal-Pro-gram	Words or phrases appearing on the display of the device are marked as display text.
	Prerequisites for the following handling instruction.
	Refer to the glossary or another text section.
	Information for safe handling.

Disposal

MELAG devices are synonymous with high quality and a long life-span. When you eventually need to decommission your MELAG device, the required disposal of the device can take place with MELAG in Berlin. Simply contact your stockist.

Dispose of accessories and consumption media which you no longer require in the appropriate manner. Comply with all relevant disposal specification in terms of possibly contaminated waste.

The packaging protects the device against transport damage. The packaging materials have been selected for their environmentally-friendly disposability and can be recycled. Returning the packaging to the material flow reduces the amount of waste and saves raw materials.

Dispose of spare parts that are no longer used, e.g. seals, properly.

MELAG draws the operator's attention to the fact that they are responsible for deleting personal data on the device to be disposed of.

MELAG draws the operator's attention to the fact that they may be legally obliged (e.g. in Germany according to ElektroG) to remove used batteries and accumulators non-destructively before handing over the device, provided they are not enclosed in the device.

2 Safety



When operating the device, comply with the following safety instructions as well as those contained in subsequent chapters. Use the device only for the purpose specified in these instructions. Failure to comply with the safety instructions can result in injury and/or damage to the device.

Qualified personnel

- As with the preceding instrument reprocessing, only ▶[competent personnel](#) should undertake sterilization using this steam sterilizer.
- The operator must ensure that the users are regularly trained in the operation and safe handling of the device.

Power cable and power plug

- Only the power cable included in the scope of delivery may be connected to the device.
- The power cable may only be replaced by an original spare part from MELAG.
- Comply with all legal requirements and locally-specified connection conditions.
- Never operate the device if the plug or power cable are damaged.
- The power cable or plug should only be replaced by ▶[authorised technicians](#).
- Never damage or alter the power plug or cable.
- Never bend or twist the power cable.
- Never unplug by pulling on the power cable. Always take a grip on the plug.
- Never place any heavy objects on the power cable.
- Ensure that the power cable does not become jammed in.
- Never lead the cable along a source of heat.
- Never fix the power cable with sharp objects.
- The mains socket must be freely accessible after installation so that the device can be disconnected from the electrical mains at any time if necessary by pulling the mains plug.

Normal operation

- The sterile filter is no longer effective if it has become wet. Stop using the sterile filter and replace it.
- Do not replace the sterile filter during a program run.

Opening the housing

- Never open the device housing. Incorrect opening and repair can compromise electrical safety and pose a danger to the user. The device may only be opened by an ▶[authorised technician](#) who must be a ▶[qualified electrician](#).

Notification requirement in the event of serious accidents in the European Economic Area

- Please note that all serious accidents which occur in connection with the medical product (e.g. death or serious deterioration in the state of health of a patient) which were presumably caused by the product, must be reported to the manufacturer (MELAG) and the relevant authority of the member state, in which the user and/or patient resides.

3 Performance specifications

Intended use

The Vacuclave 118 and 123 steam sterilizers are chiefly intended for use in the medical field. The steam sterilizers are designed as small steam sterilizers according to ▶EN 13060. They use the fractionated vacuum process to guarantee effective steam penetration of the material with saturated steam. They are suitable for reprocessing instruments and materials that may come into contact with blood or body fluids during treatment. The steam sterilizers are not intended for use on patients or in patient environments or for sterilization of liquids. Typical groups of users are physicians, trained staff and service technicians.



WARNING

Any attempt to sterilize liquids can result in a ▶delay in boiling. This can result in burns and damage to the device.

- Never use this device to sterilize fluids. It is not licensed for the sterilization of fluids.

Sterilization procedure

The steam sterilizer sterilizes on the basis of the fractionated vacuum procedure. This guarantees the complete and effective wetting/penetration of the sterilization material with saturated steam.

The steam sterilizer uses integrated steam generation to generate sterilizing steam. Steam is generated in the sterilization chamber upon program start. This establishes a pre-defined pressure and a set temperature. The sterilization chamber is protected against overheating. You can sterilize large quantities of instruments or textiles directly one after each other, thereby achieving excellent drying results.

Automatic preheater

If the preheater is activated, the cold sterilization chamber is heated up to the preheating temperature of the particular program before program start, or this temperature is held between two program runs. This reduces program times and reduces the accretion of condensation. This results in improved drying results.

Type of the feed water supply

The steam sterilizer works with a one-way ▶feed water system. This means that it uses fresh feed water (▶demineralised or ▶distilled water) for every sterilization procedure. The quality of the feed water is subject to permanent monitoring via integrated ▶conductivity measurement. If combined with a proper preparation of the instruments, this serves largely to prevent stain accretion on the instruments and soiling of the steam sterilizer.

Program runs

A reprocessing program runs in three main phases: the air removal and heating up phase, the sterilization phase and the drying phase. After program start, you can follow the program run on the display. It shows the chamber temperature and pressure as well as the time until the end of drying.

Program phases of a standard sterilization program

Program phase	Description
1. Air removal and heating up phase	Air removal In the evacuation phase, the mixture of air and steam is repeatedly evacuated and steam is generated in the sterilization chamber. This efficiently removes air from the sterilization chamber and prepares the load for sterilization. This procedure is also called the fractionated vacuum procedure.
	Heating Continued steam generation in the sterilization chamber causes an increase in pressure and temperature until the program-specific sterilization parameters are reached.
2. Sterilization phase	Sterilizing If the pressure and temperature correspond to the program-dependent nominal values, the sterilization phase begins. The corresponding process parameters (pressure and temperature) are held at sterilization level.
3. Drying phase	Pressure release The sterilization phase is followed by pressure release from the sterilization chamber.
	Drying The sterile material is dried using a vacuum (vacuum drying).
	Ventilation Upon program end, the sterilization chamber is filled with sterile air via the sterile filter and adjusted to the ambient pressure.

Program phases of the vacuum test

Program phase	Description
1. Evacuation phase	The sterilization chamber is evacuated until the pressure for the vacuum test has been reached.
2. Equilibration time	An equilibration time of 5 min will follow.
3. Measurement time	The measuring time is 10 min. The pressure increase within the sterilization chamber is measured during the measurement time. The evacuation pressure and the equilibration time or measurement time are shown on the display.
4. Ventilation	The sterilization chamber is ventilated after the end of the measuring time.
5. Test end	The display shows the test result and the leakage rate.

Safety equipment

Internal process monitoring

An independent [▶process evaluation system](#) (safety controller) is integrated in the electronics of the steam sterilizer. It compares the process parameters (such as temperature, time and pressure) during a program run. It monitors the parameters in terms of their threshold values during control and regulation and guarantees a safe and successful program run. A monitoring system checks the device components of the steam sterilizer for their functionality and their plausible interaction. If one or more parameters exceeds pre-determined threshold values, the steam sterilizer issues warning or malfunction messages and if necessary, aborts the program. In the case of a program abort, follow the instructions on the display.

The steam sterilizer uses an electronic parameter control. This enables the steam sterilizer to optimise the total operating time of a program depending on the load.

Door mechanism

The steam sterilizer constantly checks pressure and temperature in the sterilization chamber and prevents the door from being opened when over-pressure has built up.

Automatic monitoring of the feed water

The quantity and quality of the [▶feed water](#) is automatically checked before every program start.

Performance characteristics of sterilization programs

The results in this table show which inspections were performed on the device. The marked fields demonstrate compliance with all the applicable sections of the standard [▶EN 13060](#).

Type tests	Universal B	Quick B	Quick S	Gentle B	Prion B
Program type in accordance with ▶EN 13060	Type B	Type B	Type S	Type B	Type B
▶Dynamic pressure test of the sterilization chamber	X	X	X	X	X
▶Air leakage	X	X	X	X	X
▶Empty chamber test	X	X	X	X	X
▶Solid load	X	X	X	X	X
▶Porous partial load	X	--	--	X	X
▶Porous full load	X	--	--	X	X
▶Simple hollow items	X	X	X	X	X
▶Product with narrow lumen	X	X	--	X	X
▶Single wrapping	X	X	--	X	X
▶Multiple wrapping	X	--	--	X	X
Drying ▶solid load	X	X	X	X	X
Drying porous load	X	--	--	X	X
Sterilization temperature	134°C	134°C	134°C	121°C	134°C
Sterilization pressure	2.1 bar	2.1 bar	2.1 bar	1.1 bar	2.1 bar
Sterilization time	5:30 min	5:30 min	3:30 min	20:30 min	20:30 min
X = Complies with all applicable sections of the standard ▶EN 13060					

4 Description of the device

Scope of delivery

Please check the scope of delivery before setting up and connecting the device.

Standard scope of delivery

- Vacuclave 123 or Vacuclave 118
- User manual
- User manual Accessories for small steam sterilizers
- Manufacturer's inspection report and declaration of conformity
- Warranty certificate
- Record of installation and setup
- Tray lifter
- MELAG USB flash drive
- Drain hose
- Power cable
- 4 side wall cover caps
- Tool for emergency manual door opening
- 2 carrying straps

Views of the device

Front

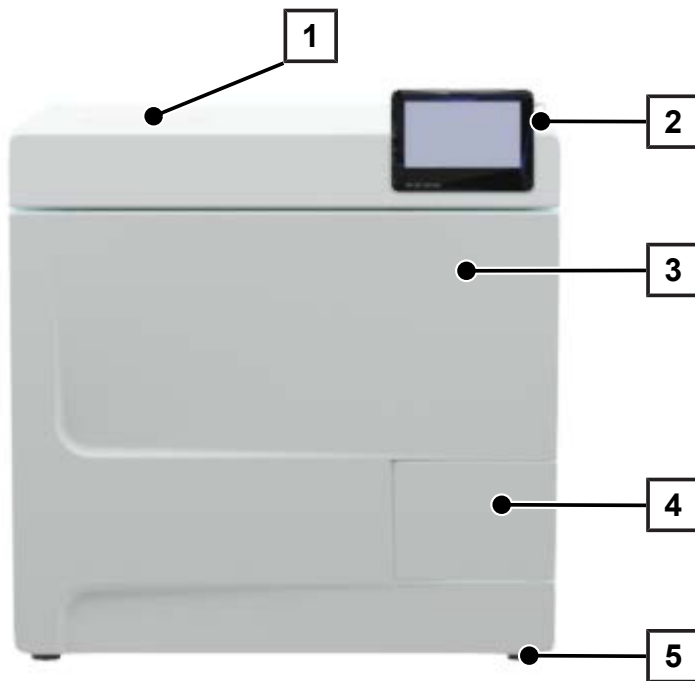

- 1 Cover, feed water side
- 2 Touch display with USB connection on the right
- 3 Door (swings open to the left)
- 4 Door handle
- 5 Front device foot (adjustable)

Rear panel

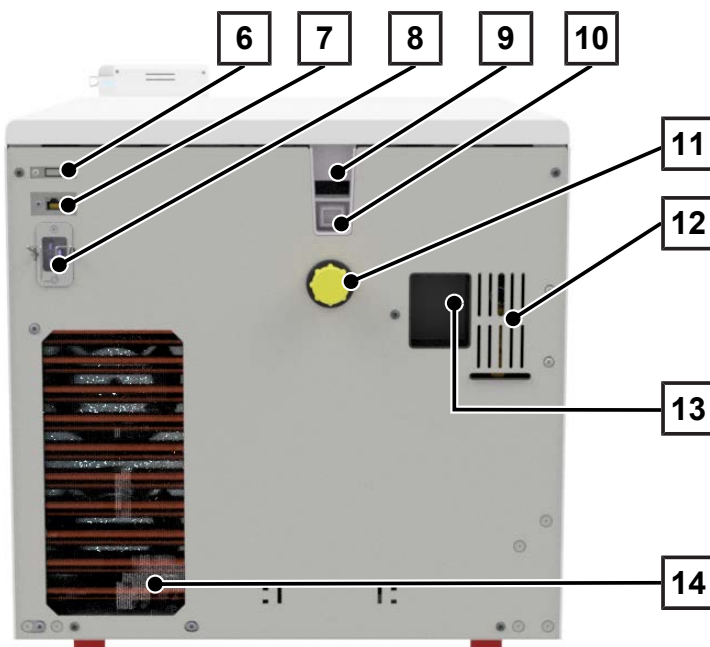

- 6 USB connection
- 7 Ethernet connection
- 8 Power cable connection
- 9 Emergency overflow (for feed water supply, internal storage tank)
- 10 Emergency overflow to EN 1717 (for automatic feed water supply and disposal)
- 11 Wastewater connection
- 12 Spring safety valve
- 13 Water treatment unit connection (optional)
- 14 Cooler

View of the interior

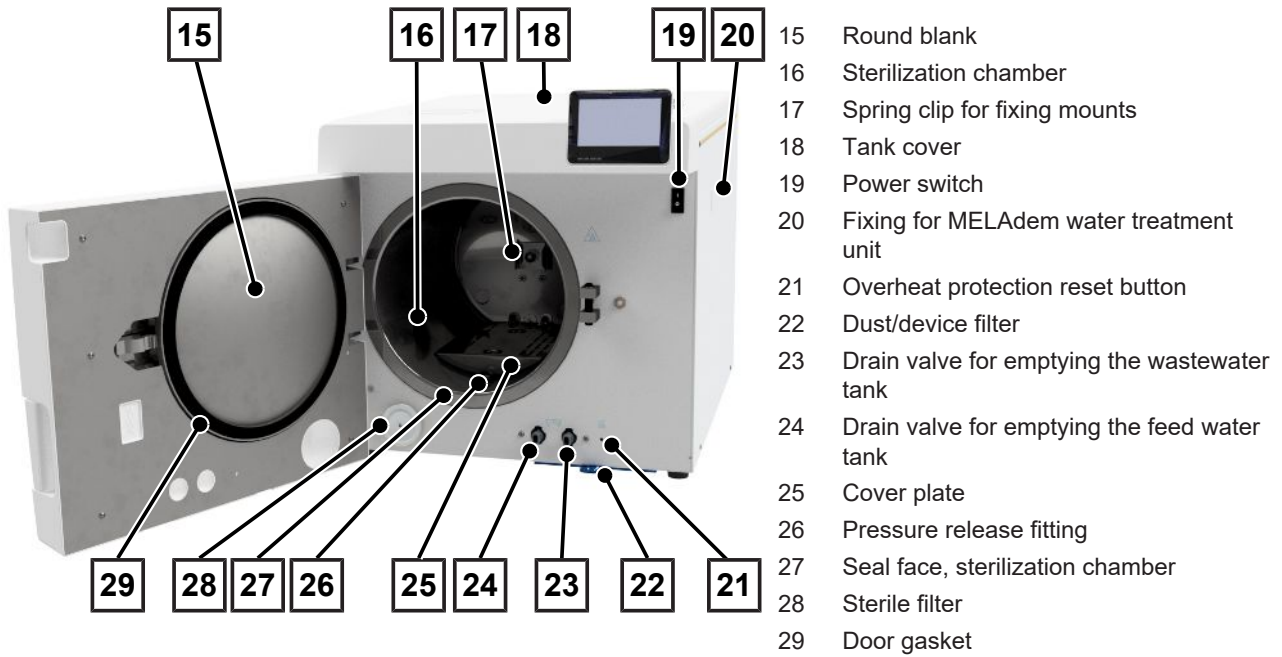

Symbols on the device

Type plate



Manufacturer of the product



Date of manufacture of the product



Label as medical product



Article number of the product



Serial number of the product

- Two-digit, alphanumeric test number for software reinstallation, separated by spaces, written in italics. The test number is not part of the serial number or the UDI.



Observe user manual or electronic user manual



Do not dispose of product in household waste



CE marking



Identification number of the notified body responsible for conformity assessment according to Pressure Equipment Directive 2014/68/EU



Identification number of the notified body responsible for conformity assessment according to Regulation (EU) 2017/745 on medical products



Volume of the sterilization chamber



Working overpressure in sterilization chamber



Operating temperature in sterilization chamber

Warning symbols



This symbol indicates that the marked area becomes hot during operation. Contact with it during or shortly after operation can pose the danger of burns.

Front of the device

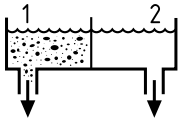

Drain valve of the internal storage tank:
1 = Wastewater side 2 = Feed water side



Reset button for the overheat protection of the capillary tube controller

Symbols on the power switch



Switching on device



Switching off device

Touch display

The user interface consists of a colour 4.3-inch touch display. On the right-hand side of the display, there is a USB port for data export (e.g. log output) and data import (e.g. software update).

The representation in the areas is dynamic and changes depending on the status of the device.

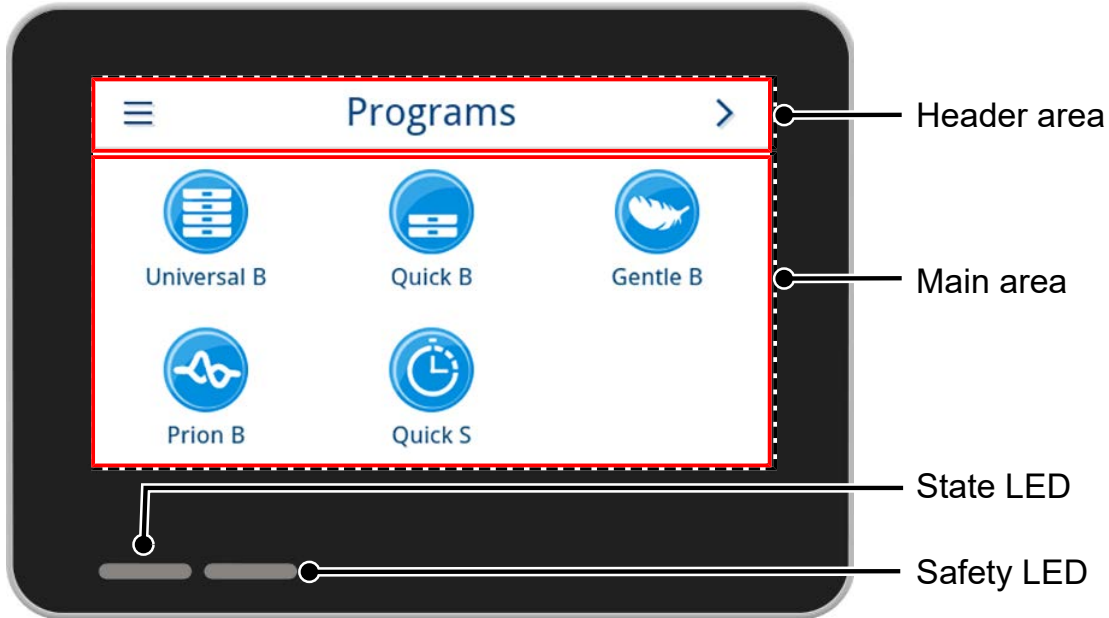

















Header area

The header area provides information about the currently opened menu and the status of the device.

The buttons or status icons are shown or hidden depending on the menu or the status of the device.

Button	Name	Description
	MENU	Open main menu
	EXIT	Exit current menu level
	OPEN	Open log for reading
	CONTINUE	Navigate forward within the menu level
	RETURN	Navigate backwards within the menu level
	DOWN	Navigate downwards within the display
	UP	Navigate upwards within the display
	DETAIL	Get further information
	OUTPUT	Open output settings for output status







Button	Name	Description
	EDIT	Edit within the Settings menu level
	ENERGY SAVING	Energy-saving mode active End energy-saving mode
	DEVICE STATUS	Open device data (e.g. serial number)
	WARNING	Warning message present Maximise warning view
	MALFUNCTION	Malfunction message present Maximise malfunction message view

Symbol	Description
	User role administrator
	User role service technician
	User role practice employee
	Computer connected
	MELAt race connected
	USB stick connected
	Door locked
	Door is locked during a running program
	Program successful
	Program not successful
	Malfunction log

Main area













In the main area, the device is controlled via buttons for program selection and for activating/deactivating functions. The program status is displayed while a program is running.

Messages and/or user instructions are displayed depending on the status of the device.

Button	Name	Description
	OPTIONS	Open the program options of the displayed program Activate or deactivate program options
	EDIT	Switch to the settings level
	SELECT	Change or select parameters
	SELECT	Change or select parameters
	ACTIVATE	Select several parameters, functions or output media <ul style="list-style-type: none"> Blue background = selection/activation Grey background = no selection/activation
	ACTIVATE	Selection of a parameter or a function <ul style="list-style-type: none"> Blue tick = selection/activation Grey tick = no selection/activation
	OFF/ON	Activate (ON) or deactivate (OFF) functions <ul style="list-style-type: none"> Blue background = active selection

LED display and acoustic signals

Two independent safety systems continuously monitor the sterilization process during each program run. The status LED indicates the status of the device with the colours blue, green, yellow or red. The safety LED only lights up red if a program has not been completed successfully or if there is a malfunction. An acoustic signal is linked to the colour of the LED display and indicates an expected event.

State LED	Safety LED	Description	Safety instructions
 Blue	--	<ul style="list-style-type: none"> Device started 	--
 Blue	--	<ul style="list-style-type: none"> Door unlocked/opened Door open for more than 120 seconds 	
 Green	--	<ul style="list-style-type: none"> Program successfully completed 	
 Yellow	--	<ul style="list-style-type: none"> Warning message 	
 Blue  Green  Yellow  Red	 Red	<ul style="list-style-type: none"> Malfunction Program not successfully completed 	WARNING! If the safety LED lights up red, there is a malfunction and the program was not completed successfully. The load was not sterilized!
 Red	 Red	<ul style="list-style-type: none"> Abort program run (before start of Drying program phase) 	
 Blue	--	<ul style="list-style-type: none"> Energy-saving mode Software update is running Device in operation No program active Program in progress 	--

Load mount

Note the following depending on the use of the accessories:

A spring clip (pos. a) is located on the rear panel of the sterilization chamber to fix the mount. When using an A Plus mount, slide the mount (pos. b) into the sterilization chamber to its fullest extent, until the mount snaps into the spring clip audibly and noticeably. To remove the mount, pull it out of the spring clip with both hands.

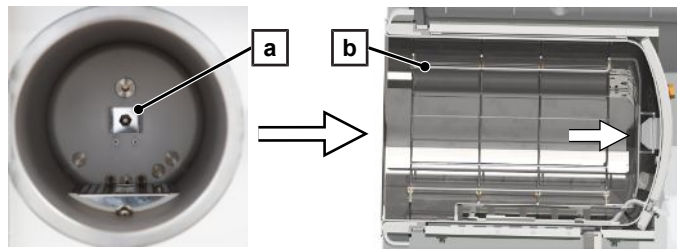

The A Plus mount can be used for sterilization of soft-packed goods (e.g. in MELAfol) on trays. A combination of trays (short or long) can be arranged on up to five levels or, turned by 90°, three MELAstore Box 100. The mount is fixed in the device and remains in the sterilization chamber during loading and unloading.



Up to two MELAstore Box 200 can be sterilized directly in the chamber without a mount.

For detailed instructions on the use of the accessories and their combinability with different load holders, see the document "User manual Accessories for small steam sterilizers".

5 Installation requirements

Installation location



WARNING

Failure to comply with the setup conditions can result in injuries and/or damage to the device.

- The steam sterilizer should only be setup, installed and commissioned by persons authorised by MELAG.
 - The steam sterilizer is not suitable for operation in explosive atmospheres.
 - The steam sterilizer is conceived for use outside the patient care area. The device should be located a minimum of 1.5 m radius away from the treatment area.
-

Steam egress can occur during operation. Do not set up the device in the immediate proximity of a smoke detector. Maintain clearance from materials which could suffer damage from steam.

Make sure that the ambient conditions meet the requirements, see [Technical data](#) [▶ page 91].

Electromagnetic environments

When assessing the Electromagnetic Compatibility (EMC) of this device, the emitted interference threshold values for Class B devices and the stability for operation in an electromagnetic environment as described in IEC 61326-1 were taken as the basis. The device is thus suitable for operation in all institutions and domestic settings connected to a public mains power supply. The floor should be made of wood or concrete or be tiled with ceramic tiling. If the floor is fitted with synthetic material, the relative humidity must amount to a minimum of 30 %.

Space requirements

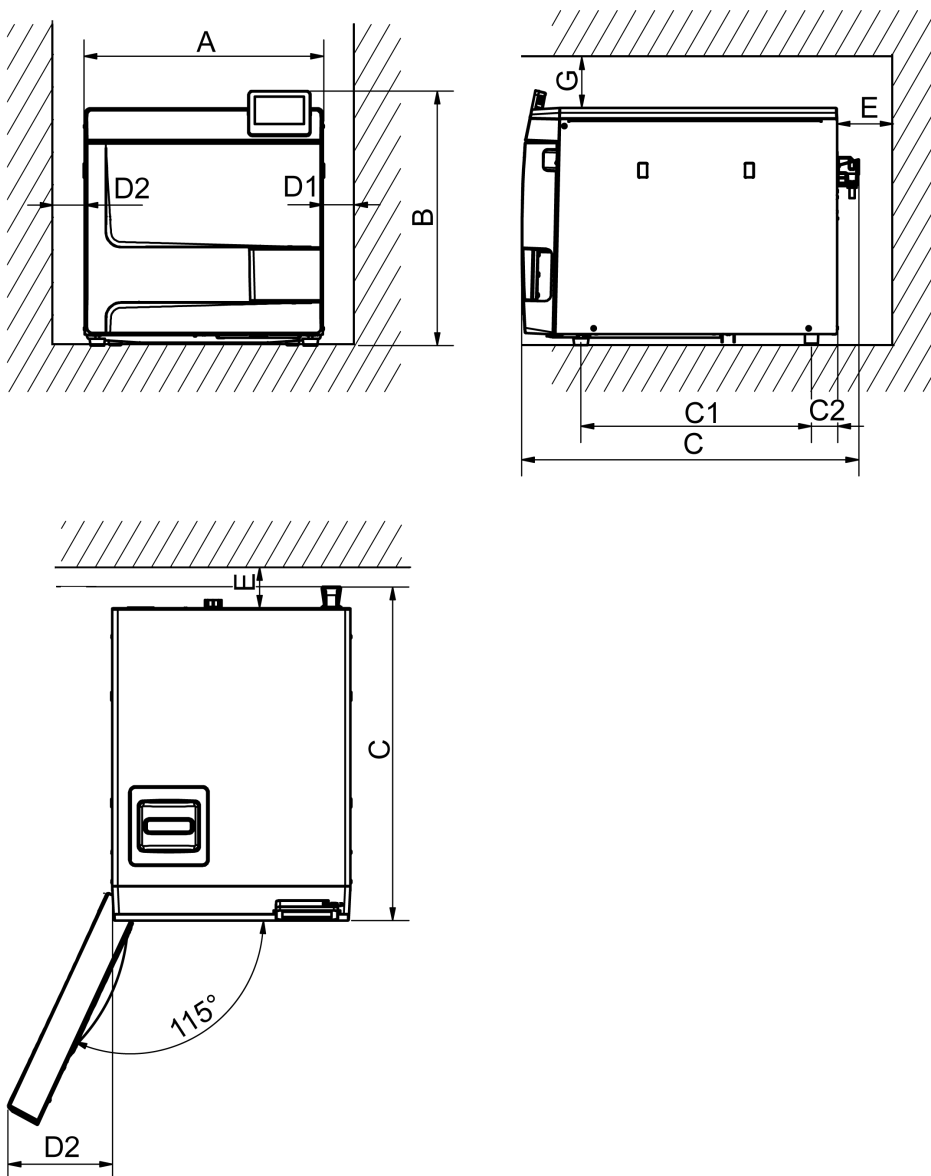

Dimensions		Vacuclave 118	Vacuclave 123
Width	A	47 cm	
Height	B	50 cm	
Depth, total	C	64 cm	
Clearance between the device feet	C ₁	45 cm	
Clearance from rear device foot up to the rear panel	C ₂	5 cm	
Min. clearance to the side	D ₁	5 cm	
Min. clearance to the side of the door hinge	D ₂	10 cm	
Min. clearance to the rear	E	5 cm	
Min. clearance to the top (can be pulled out / with exhaust shaft)	G	5 cm	

The area above the steam sterilizer should be freely accessible in order to enable easy filling of the storage tank and good ventilation.

The steam sterilizer works with a cooler on the rear of the device. The function and life-span of the steam sterilizer can be compromised if heat dissipation via the cooler is restricted in any way. The steam sterilizer may only be installed if sufficient air circulation can be guaranteed.

Additional space requirement for the feed water supply

Additional space is required if the device is operated with a water treatment unit. It is necessary to guarantee free access to the hoses and cables of the device leading to the water treatment unit.

Space requirements	MELAdem 40	MELAdem 47	
		Water treatment unit	Pressure tank
Width	32 cm	40 cm	--
Height	35 cm	46 cm	40 cm
Depth	16 cm	18 cm	--
Diameter	--	--	28 cm

Requirements for installing the device

If it is absolutely necessary to install the device, implement one of the following measures:

1. It must be possible to pull out the device for operation (pos. a).
2. In the installation space, there must be an exhaust shaft in the rear area that discharges the warm air upwards (pos. b).
3. There must be an exhaust shaft in the rear area of the installation space that actively discharges the warm air to the rear (pos. c).

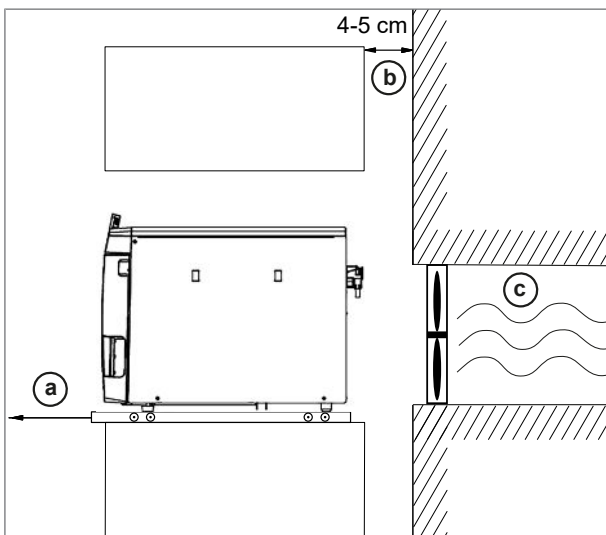

Mains connection

Make sure that the electrical connection meets the requirements on site, see [Technical data](#) [► page 91].

Water connection

	Feed water		Wastewater
Connection in the practice	Vacuclave 118	Vacuclave 123	Manual draining via the wastewater tank Optional: automatic disposal with the water connection kit Wall outlet, nominal width DN 40 or to a U-trap (flush outflow)
Installation height	--		min. 30 cm under the steam sterilizer
Measures for protecting the drinking water	For hygienic reasons, the device is separated from the wastewater with a free fall section; this requires an open construction. The wastewater must always be able to flow freely and unhindered to the wall outlet. The maximum length of the outlet hose must not exceed 2.5 m. In addition, the device is separated from the feed water supply on the feed water side by a free drain.		

Connection of a water treatment unit

	MELAdem 40	MELAdem 47
Permissible hydraulic pressure	1.5-10 bar	2-6 bar
Water stop	For insurance reasons, MELAG recommends the installation of a water stop with a cut-off valve (e.g. from MELAG), as the MELAdem 40/MELAdem 47 are under constant hydraulic pressure from the domestic water supply.	



PLEASE NOTE

Fit the outlet hose at a constant decline without kinks or sagging. In case of deviations to the installation arrangements, consult with MELAG.

Failure to do so can result in malfunctions of the device.

System and network safety

The device is fitted with multiple external interfaces. Comply with the following information pertaining to the use of these interfaces to ensure safe operation of the device, especially to ensure incorporation in the local network (LAN).

Interfaces and connections



NOTICE

Only connect the hardware to the device which is listed in the following table. Only use the software which has been intended for the purpose and approved by the manufacturer.

Interface	Type	Hardware	Software/purpose
USB (Display)	Type A configured as <i>Host</i>	MELAG USB flash drive with FAT32 file system	Saving log data
		MELAG USB flash drive with FAT32 file system and software-update container	Device software update
USB (Display)	Type A configured as <i>Device</i> ¹⁾	USB type-A socket	Save MELAview service log data, query device data
			MELAtrace saving log data
USB (rear of the device)	Corresponds to the host configuration of the USB interface on the display		
Ethernet	Ethernet IEEE 802.3	Switch port (Practical network)	Save MELAview service log data, query device data
			MELAtrace saving log data
			FTP server saving log data
			Connection to the practice's network



NOTICE

When performing a device software update, use only the update data authorized by MELAG for the corresponding device type.

¹⁾ Activate in the Service menu > MELAview

Operating the device with memory media

To prevent data loss, only use memory media to save the log data with the following characteristics:

- functional (without malware, etc.)
- Writeable
- Formatted with a correct file system

Perform regular data backup. Restrict access to the device and systems with access authorisation to the necessary circle of persons.

Only use MELAG USB flash drives.

Operating the device in the local network (LAN)



NOTICE

Do not connect the device to a public network (e.g. the internet).

An Ethernet/IP-based network connection (LAN) is required to operate the device in a local network. In its delivery state, the device is configured to obtain the IP address automatically from a DHCP server operated in a LAN.



NOTICE

Check the IP address carefully during the conversion for a manual configuration before connecting the device to the LAN.

An incorrectly-entered IP address can cause IP conflicts in the network and thus disturb another device in your network.

In the LAN with a firewall, only permit connections to and from the device which correspond to the intended use of the device. All ports not used are blocked on the device side.

The device is able to make the following connections as standard:

Log	Source port	Destination port	Direction	Purpose
TCP	63000 - 64000	21	Outgoing	FTP control
TCP	any	63000 - 64000	Listening/ Incoming	FTP (passive) data transfer (device set to FTP logging)
UDP	68	67	Outgoing	Communication to DHCP server - requests to the DHCP server
UDP	67	68	Listening/ Incoming	Answers from DHCP server(s)
TCP	any	3333	Listening/ Incoming	Data transfer log data (device set to TCP logging)
UDP	62000	3000	Outgoing	Broadcast search printer
UDP	3000	62000	Listening/ Incoming	Search answers printer
TCP	≥ 1025	9100	Outgoing	Data transfer to the printer

Network bandwidth / Quality of Service (QoS)

The device does not place any requirements on the LAN bandwidth for data transfer, that exceed the standard time-out times of the respective logs.

Process	Volume max.	Volume normal
Program log	1 MB	200 kB
Malfunction log	64 kB	10 kB

6 Setup and installation



WARNING

Improper installation may lead to a short-circuit, fire, water damage or electrical shock.

This could result in serious injury.

- Only have the device set up, installed and commissioned by people authorised by MELAG.
-

Comply with the following for safe handling:

- The connections for electrical provision and water supply and discharge must be setup by trained personnel.
- Using the optional electronic leak detector (water stop) minimises the risk of water damage.
- Install and operate the device in a frost-free environment.
- For the initial commissioning, observe all instructions described in the user manual.
- The spring safety valve must be able to move freely and not become stuck or blocked. Position the device in such a way that the faultless functioning of the spring safety valve is guaranteed.

Removing from the packaging



CAUTION

Danger of injury from incorrect carrying.

Lifting and carrying too heavy a load can result in spinal injury. Failure to comply with these provisions can result in crushing.

- The device should always be carried by two people.
 - Comply with the safety regulations issued by your professional association.
-

1. Remove the steam sterilizer from the box using the carrying straps.
2. Check the device after unpacking for any damage suffered during transport.
3. To remove the straps, loosen the four knurled screws.

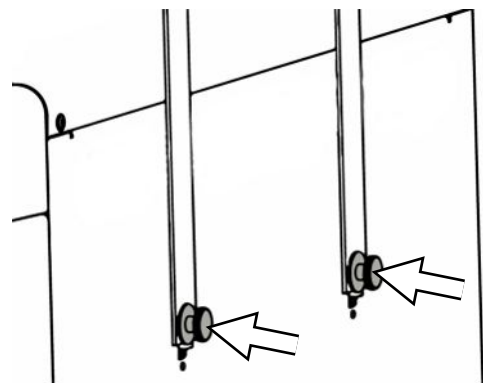

4. Pull the fastening system out of the device openings and unhook the carrying straps from the side wall.

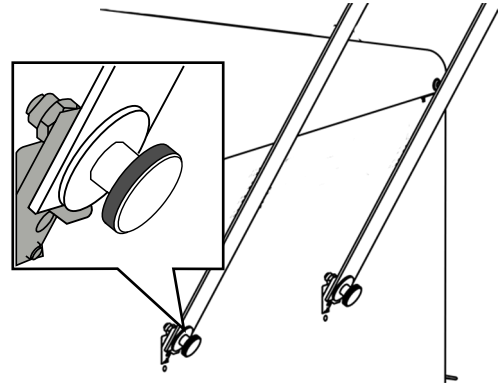

5. Attach the cover caps to the device openings for the fastening system.

Use of a water treatment unit

A water treatment unit is directly connected to the drinking water supply. The respective system is selected in accordance with the number of sterilization runs per day and the type of the load.



PLEASE NOTE

Should you wish to use a water treatment unit from another manufacturer, please consult MELAG.

Installation examples

On the following pages, you will find examples of the recommended installation types for the feed water supply.



PLEASE NOTE

For detailed information on the cold water connection of the water treatment unit, see the user manual of the unit.

Example 1 - Manual water supply and disposal via internal storage tanks (as-delivered condition)

The feed water is supplied from the feed water tank without an additional water connection. Wastewater disposal is from the wastewater tank without an additional wastewater connection.

A float switch integrated in the feed water tank signals the absence of feed water. Programs can only be started after feed water has been filled. The used feed water (wastewater) is collected in the wastewater tank and is emptied manually later. A float switch in the wastewater tank also signals a full wastewater tank.

No further installation is required apart from the electrical connection.

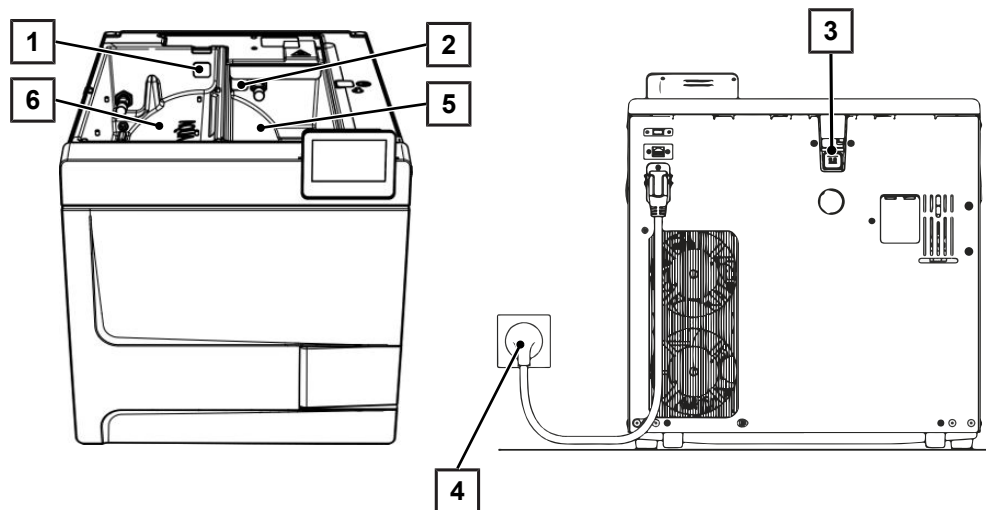

Pos.	Description	Art. no.	contained in
1	Feed water tank Tank plug	ME22273	included on the device side
2	Wastewater tank Tank plug	ME22273	included on the device side
3	Water overflow Tank plug	ME22273	included on the device side
4	Mains connection	--	included on the device side
5	Wastewater tank	--	included on the device side
6	Feed water tank	--	included on the device side



PLEASE NOTE

When operating with the internal storage tanks, check that all tank plugs (feed water tank, wastewater tank and water overflow) are correctly inserted in the device.

Example 2 - Automatic water supply and disposal with MELAdem 40 ion exchanger

The MELAdem 40 can be attached to the side of the device. Alternatively, it can also be attached to the wall or in the base cabinet with the help of the holders for wall mounting.

Automatic water disposal should always be installed in case of automatic water supply. Install the required water connection kit as described in the separate instructions (doc. AS_009-22, AS_011-22). In addition, it is necessary to install a water stop.

1. The wastewater is collected in the wastewater tank (right) and automatically drained via the outlet hose connected to the wastewater funnel.

Connect the outlet hose to the existing U-trap of the building's wastewater system. The U-trap used must be ventilated so that the water can drain off without resistance. Double-chamber U-traps, for example, are not suitable.

PLEASE NOTE: Lay the outlet hose kink-free and with a continuous falling gradient from the wastewater funnel to the U-trap.

2. Remove the water overflow tank plug and the tank plugs in the feed water and wastewater tanks.
3. Fasten the safety combination HD to the wall. When doing so, pay attention to the flow direction indicated on the safety combination. Observe the minimum distance of the fall section (25 cm) above the water treatment unit.

PLEASE NOTE: Installation in the drinking water system compliant with EN1717 requires a water tap with hose union anti-vacuum valve combined with a check-valve.

4. Please set the water supply and disposal to **Automatic** in the **Settings** menu, see [Water](#) [▶ page 70].



NOTICE
Improper installation

There is a risk of water damage if the water connection is installed improperly.

- Check all water connections and joints!

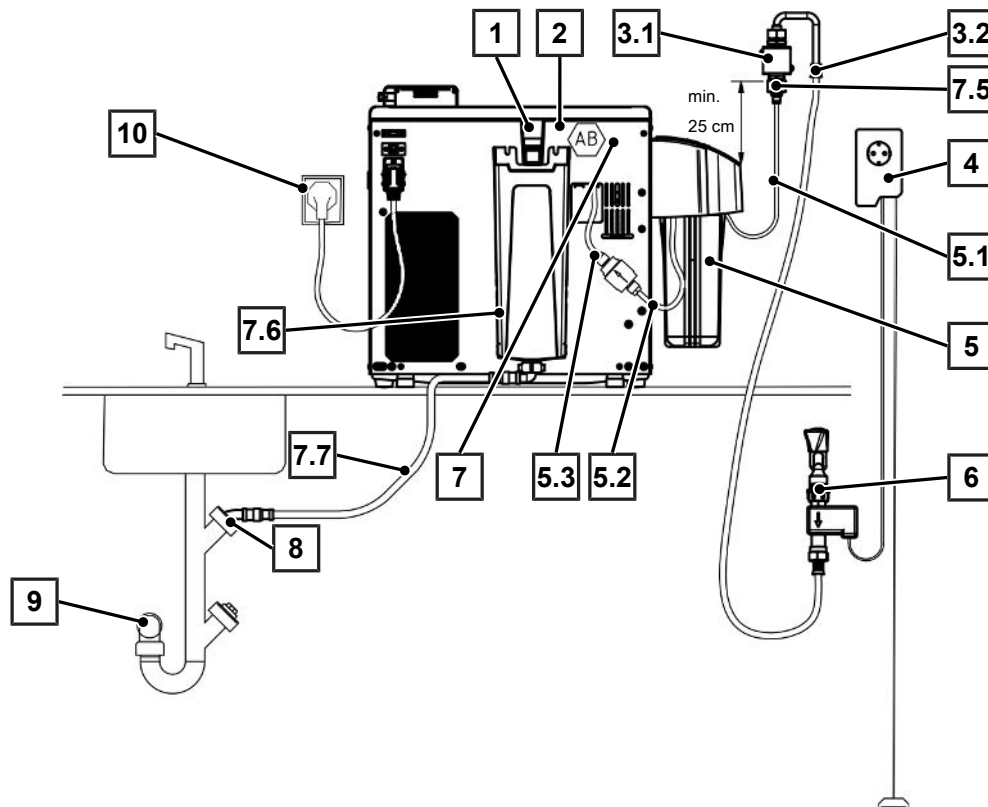

Pos.	Description	Art. no.	contained in
1	Emergency overflow	--	included on the device side
2	Free outlet AB (integrated in the tank/behind the rear panel)	--	included on the device side
3.1	Safety combination HD with wall mount incl. hose, 2.5 m	ME70686	not included in scope of delivery
3.2	Tap water supply hose EN 1717, 2.5 m	ME24930	ME70686
4	Water stop (leak water detector) with cut-off valve and sensor	ME01056	not included in scope of delivery
5	MELAdem 40 ion exchanger	ME01049	not included in scope of delivery
5.1	PUR hose (6/4 mm, 1.5 m)	ME28820	ME01049
5.2	PUR hose (6/4 mm, 1.5 m)	ME28820	ME01049
5.3	Filter for MELAdem	ME48240	ME01049
6	Water tap 3/4" with safety combination	ME37310	provided on site
7	Water connection set for Vacuclave 100/300/SteriHero	ME09040	not included in scope of delivery
7.1*	Solenoid valve, external water inflow	ME80057	ME09040
7.2*	Inflow fitting, feed water	ME80068	ME09040
7.3*	Seal pressure release nozzle tank	ME21247	ME09040
7.4*	KL locking device	ME21248	ME09040
7.5	Cold water adapter 3/4" to 1/4" (direct connection water hose)	ME09037	ME09040
7.6	Wastewater funnel	ME22913	ME09040
7.7	Hose for water drain of steam sterilizers, 2 m	ME36585	ME09040
8	Wastewater connection vented to the top (washing machine connection)	--	provided on site
9	Wall outlet (at least DN40)	--	provided on site
10	Mains connection	--	provided on site

*) concealed behind rear wall of device



PLEASE NOTE

Before converting from the standard version to a water treatment unit, you must first empty the feed water side (right-hand chamber) of the internal storage tank. With automatic one-way outlet, the wastewater side (left-hand chamber) must be emptied as well.

Example 3 - Automatic water supply and disposal with MELAdem 47 reverse osmosis unit

Automatic water disposal should always be installed in case of automatic water supply. Install the required water connection kit as described in the separate instructions (doc. AS_009-22, AS_011-22). In addition, it is necessary to install a water stop.

1. The wastewater is collected in the wastewater tank (right) and automatically drained via the outlet hose connected to the wastewater funnel.

Connect the outlet hose to the existing U-trap of the building's wastewater system. The U-trap used must be ventilated so that the water can drain off without resistance. Double-chamber U-traps, for example, are not suitable.

PLEASE NOTE: Lay the outlet hose kink-free and with a continuous falling gradient from the wastewater funnel to the U-trap.

2. Remove the water overflow tank plug and the tank plugs in the feed water and wastewater tanks.
3. The concentrate of the water treatment unit is discharged via an on-site protection according to EN 1717 (e.g. Otto Haas).
4. Fasten the safety combination HD to the wall. When doing so, pay attention to the flow direction indicated on the safety combination. Observe the minimum distance of the fall section (25 cm) above the water treatment unit.

PLEASE NOTE: Installation in the drinking water system compliant with EN1717 requires a water tap with hose union anti-vacuum valve combined with a check-valve.

5. Please set the water supply and disposal to **Automatic** in the **Settings** menu, see [Water](#) [▶ page 70].



NOTICE
Improper installation!

There is a risk of water damage if the water connection is installed improperly.

- Check all water connections and joints.

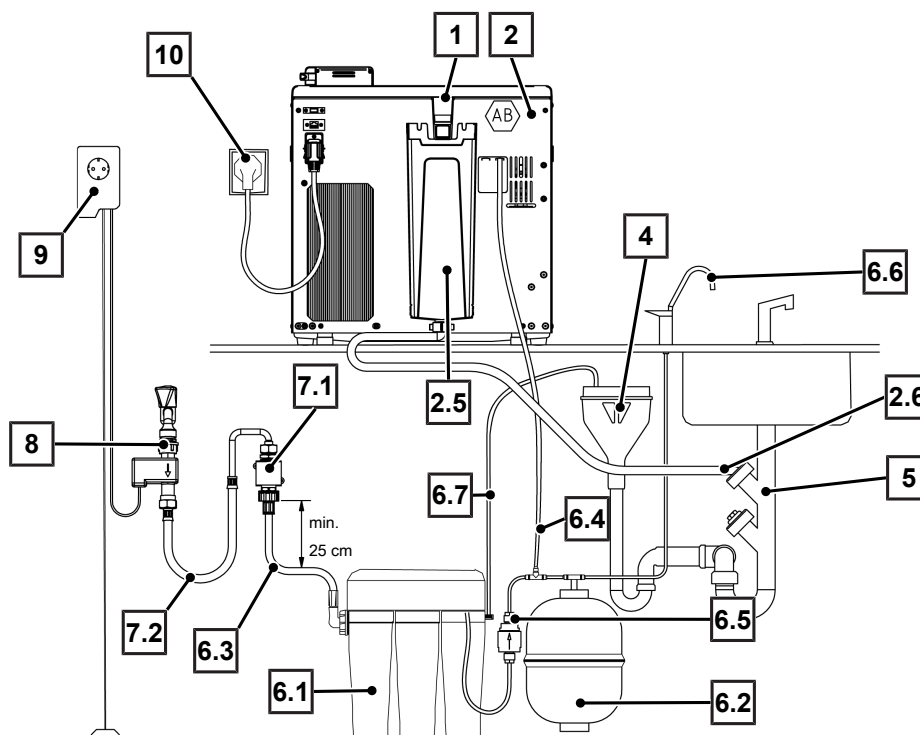

Pos.	Description	Art. no.	contained in
1	Emergency overflow	--	included on the device side
2	Water connection set for Vacuclave 100/300/SteriHero	ME09040	not included in scope of delivery
2.1*	Solenoid valve, external water inflow	ME80057	ME09040
2.2*	Inflow fitting, feed water	ME80068	ME09040
2.3*	Seal pressure release nozzle tank	ME21247	ME09040
2.4*	KL locking device	ME21248	ME09040
2.5	Wastewater funnel	ME22913	ME09040
2.6	Hose for water drain of steam sterilizers, 2 m	ME36585	ME09040
4	On-site protection (free outlet according to EN 1717)	--	provided on site
5	Wastewater connection vented to the top (washing machine connection)	--	provided on site
6	MELAdem 47 reverse osmosis unit	ME01047	not included in scope of delivery
6.1	MELAdem 47 reverse osmosis unit (without accessories)	ME56740	ME01047
6.2	Pressure tank MELAdem 47 (with shut-off valve and hose)	ME57065	ME01047
6.3	Water inflow hose (2.5 m)	ME37220	ME01047
6.4	PUR hose (6/4 mm, 1.5 m)	ME28820	ME01047
6.5	Filter for MELAdem	ME48240	ME01047
6.6	External tap for demineralised water	ME91900	ME01047
6.7	PUR hose (6/4 mm, 1.5 m) (concentrate line)	ME28820	ME01047
7.1	Safety combination HD with wall mount incl. hose, 2.5 m	ME70686	not included in scope of delivery
7.2	Tap water supply hose EN 1717, 2.5 m	ME24930	ME70686
8	Water tap 3/4" with safety combination	ME37310	provided on site
9	Water stop (leak water detector) with cut-off valve and sensor	ME01056	not included in scope of delivery
10	Mains connection	--	provided on site

*) concealed behind rear wall of device



PLEASE NOTE

Before converting from the standard version to a water treatment unit, you must first empty the feed water side (right-hand chamber) of the internal storage tank. With automatic one-way outlet, the wastewater side (left-hand chamber) must be emptied as well.

Aligning the device

For a fault-free operation, set up the device **horizontally** by using a spirit level so that the residual water/condensate can drain out of the sterilization chamber.

1. Remove the cover of the feed water tank.



2. Remove the tank cover from the device.

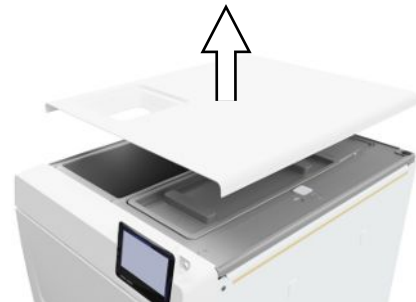

3. Position a spirit level on the right edge of the wastewater tank and on the front area of the internal storage tanks.

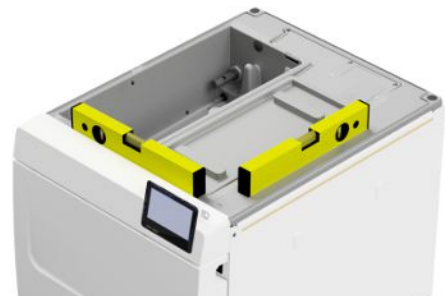

4. If necessary, shut off or turn on the front device feet.
5. Hook the tank cover onto the rear of the device and pull the tank cover forward until it clicks into place. Then fold the tank cover onto the device.

PLEASE NOTE: The tank cover must rest evenly on the device on all sides.

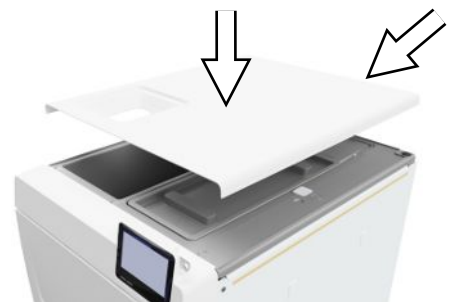

6. Put the feed water tank cover back on the device.

Electrical test in accordance with EN 50678 (VDE 0701) or national standard

This check is only necessary if the housing has been opened for mounting the solenoid valve or the wastewater funnel.

Connecting the mains cable and removing accessories



NOTICE

Before switching on for the first time, the device must have acclimatised to the required ambient temperature (5-40 °C).

1. Connect the power cable (pos. b) to the back of the steam sterilizer and fold down the safety latch (pos. a).



2. Plug the power plug of the device into the power socket of the practice.
3. Switch on the device at the power switch. The start screen appears on the display.

PLEASE NOTE: The device displays a warning after start-up due to a lack of feed water. Press  to minimize the message.

4. Open the door.
5. Remove all accessories from the sterilization chamber.
6. Close the door.

Checking the software version

1. Open the status of the device with  in the header of the display.
2. Check the software version.
3. Update the software if necessary, see [Software update](#) [▶ page 76].

Checking water supply and disposal

1. Check the water supply and disposal in the **Settings** menu, see [Water](#) [▶ page 70].
2. If necessary, set the water supply and disposal according to the installation, see [Installation examples](#) [▶ page 26].

Checking date and time

Date and time of the device must be correctly set for proper batch documentation. Ensure that you take into account any clock change, as this is not adjusted automatically.

1. Check the date and time in the header of the display.
2. If necessary, set the date and time in the **Settings** menu, see [Date](#) [▶ page 60] and [Time](#) [▶ page 61].

Setting the display

If necessary, adjust the brightness in the **Settings** menu and activate/deactivate the signal tone, see [Display](#) [▶ page 62] and [Audio](#) [▶ page 63].

Test runs

Carry out the test runs following installation.

Vacuum test with cold sterilization chamber

Perform a **Vacuum test chamber** with an empty cold sterilization chamber and record the result.

Universal-B Program

If the vacuum test was successful, run a **Universal B** program with 1.5 kg load (instruments) and record the result.

Check for leaks

After the **Universal B** program, check the installed hose connections for leaks.

Instructing the users

Explain all the user-typical features for the documentation and setting combinations for the operator.

Hand over the manufacturer's inspection report. The declaration of conformity of the Pressure Equipment Directive and the Medical Devices Regulation are included in the manufacturer's inspection report.

Record of installation and setup

The record of installation is to be completed by the responsible stockist and a copy sent to MELAG as proof of the correct setup, installation and initial commissioning. This is a constituent part of any guarantee claim.

7 First steps

Switching on the device

The following must be fulfilled or present:

- ✓ The device is connected to the power supply.
- ✓ The feed water supply is secure. The steam sterilizer requires min. 1.25 l of feed water for the first filling of the steam sterilizer.

1. Switch the device on or off at the power switch (see circular marking).

PLEASE NOTE: The safety LED lights up briefly while the device is starting. This is a self-test.



- ➔ The start screen appears on the display.
- ➔ The feed water level is checked immediately after activation.



PLEASE NOTE

In the case of automatic feed water supply, the device attempts to supply feed water after start-up. If no feed water is available yet, a malfunction message is displayed, see [Malfunctions](#) [▶ page 85].

2. Wait until the **Programs** menu is displayed.

PLEASE NOTE: You can start a program immediately without waiting for the preheating time.

Within the first 60 s after the device is started, press > to switch to the [Service programs](#) [▶ page 56] menu, to prevent automatic preheating.



Opening and closing the door

The device has an automatic locking mechanism that ensures that the door cannot be opened until it has been unlocked automatically (after starting the device) or by the user (after the program run).

The door is locked when:

- The device is switched off
- The device is in a currentless condition
- The device is in energy-saving mode
- A program is running

Opening the door

After switching on the device

The following must be fulfilled or present:

- ✓ The device is switched on and booted up.
- ✓ An audible click is heard.
- ▶ Pull the door handle carefully and not forcibly.

PLEASE NOTE: The door is to be left open only whilst loading and unloading the device. Keeping the door closed saves energy.



After a program run

The following must be fulfilled or present:

- ✓ The program is ended.
 - ✓ The **Unlock door** button has been pressed.
1. An audible click is heard and the adjacent note is displayed.



2. Pull the door handle carefully and not forcibly.

Close the door

! **NOTICE**
Do not slam the door.

- ▶ Press the door lightly against the device and fold in the door handle.



- ➔ After the door has been closed, the display changes to the **Programs** menu.

Manual door emergency-opening



CAUTION

Danger of scalding from hot steam!

On opening the door, steam and hot water can escape from the sterilization chamber. e.g. if it is necessary to open the door immediately after the end of a program. This could result in scalding.

- Should steam be issued from the rear of the device after its deactivation, wait until the procedure has finished. Wait a further 5 min before opening the door.
- Stand to one side of the door and maintain sufficient distance.
- Allow the sterilization chamber to cool before removing the load.

The door can be opened manually via the emergency opening following a power failure or malfunction.

The following must be fulfilled or present:

- ✓ The device has been switched off.
 - ✓ The device has been completely cooled.
1. Remove the cover of the feed water tank.



2. Remove the tank cover from the device.



3. Remove the closure plug (see circular marking) using the tool supplied.



- Using the tool supplied, pull the ring under the closure plug slightly upwards and, at the same time, carefully open the door.

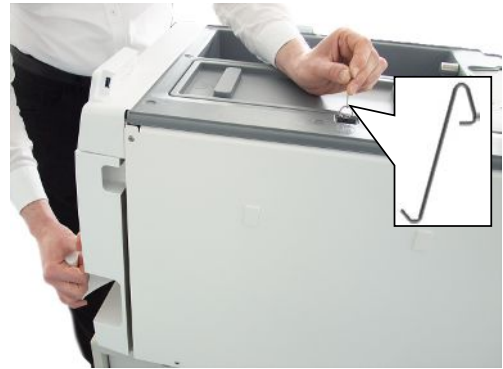

- Place the ring back in its original position.
- Replace the closure plug.
- Hook the tank cover onto the rear of the device and pull the tank cover forward until it clicks into place. Then fold the tank cover onto the device.

PLEASE NOTE: The tank cover must rest evenly on the device on all sides.

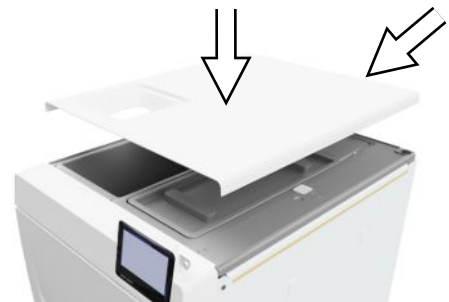

- Put the feed water tank cover back on the device.

Feed water supply

Steam sterilization requires the use of **distilled** or **demineralized water**, known as **feed water**. Annex C of **EN 13060** specifies the guideline values to be observed.

The **feed water** supply is effected either via the internal storage tank or via a separate water treatment unit (e.g. MELAdem 40/MELAdem 47).

Using the feed water tank

For the feed water supply via the internal storage tank, you must fill it manually. At the appropriate time, a corresponding message is shown on the display. The feed water tank (left) holds a maximum of 5.3 l. This volume of feed water is sufficient for up to 7 sterilization runs. The steam-generating system requires at least 1.25 l to secure the feed water supply.

Filling the feed water tank

- Remove the lid of the feed water side and fill the feed water side with fresh feed water up to the MAX mark (see circle marking).



- For a feed water supply via the internal storage tank, set the water supply to **Manual** (delivery state).

Disposal of the wastewater

- ▶ The wastewater can either be collected in the wastewater tank (right) and removed manually or be drained automatically via the wastewater connection.



An upgrade kit can be ordered to connect the device to the wastewater connection. For detailed information on connecting to the wastewater, see [Installation examples](#) [▶ page 26].

8 Important information for routine operation

Comply with the recommendations issued by the Robert Koch Institute (▶RKI) and the information contained in ▶DIN 58946-7.

Manufacturer’s recommendation for the routine operation of type B steam sterilizers ²⁾

When is it necessary to make checks?	How should the checks be made?
Once per working day	<ul style="list-style-type: none"> ▪ Visual check of the door seal and the door lock for damage ▪ Check the operating media (electricity, ▶feed water and water connection if necessary) ▪ Check the documentation media (printer paper, computer, network) <p>MELAG recommends performing the steam penetration test with MELAcontrol Helix/MELAcontrol Pro in the Universal-Program (test system in accordance with ▶EN 867-5).</p>
Once a week	<ul style="list-style-type: none"> ▪ Vacuum test <p>Tip: In the mornings before starting work – the steam sterilizer must be cold and dry</p>
Batch-related tests	<p>With “Critical B” instruments:</p> <ul style="list-style-type: none"> ▪ MELAcontrol Helix/MELAcontrol Pro must be used as ▶batch control with every sterilization cycle. <p>With “Critical A” instruments:</p> <ul style="list-style-type: none"> ▪ The process indicator (type 5 in accordance with ▶EN ISO 11140) must be used as batch control with every sterilization cycle. <p>With “Critical A + B” instruments:</p> <ul style="list-style-type: none"> ▪ MELAcontrol Helix/MELAcontrol Pro must be used as batch control with every sterilization cycle. <p>This simplifies the working procedure and increases security. You can omit the daily steam penetration test with MELAcontrol Helix/MELAcontrol Pro (see above). The use of another test system in accordance with ▶EN 867-5 is possible. The number of the available test systems means that MELAG is not able to provide technical support when using a different system.</p>



PLEASE NOTE

Document the results of the tests.

- The indicator test strips used need not be stored.

²⁾in accordance with the current recommendations from the Robert Koch Institute

9 Sterilization



Preparing the load

Always clean and disinfect properly before sterilization. Only in this way is it possible to guarantee the subsequent sterilization of the ▶load. The materials used, cleaning agents and reprocessing procedure are of decisive significance.

Comply with the following for safe handling:

- Only ever use packaging material and systems which have been cleared by their manufacturer for steam sterilization.
- Use only original MELAG accessories or those from other suppliers authorised for use by MELAG.

Reprocessing the instruments

Unwrapped sterile material loses its sterility on contact with ambient air. If you intend to store your instruments sterilely, wrap them in suitable packaging before sterilization.

Ensure the following when reprocessing used and brand-new instruments:

- Observe both the instrument manufacturer's instructions regarding reprocessing and sterilization as well as the relevant standards and directives (in Germany, for example, from ▶RKI, ▶DGSV and ▶DGUV Regulation 1).
- Clean the instruments exceptionally thoroughly e.g. using an ultrasonic device or washer-disinfector.
- Rinse the instruments after cleaning and disinfecting, where possible with demineralised or distilled water and then dry the instruments thoroughly with a clean, non-fuzzing cloth.
- Use only those care agents suitable for steam sterilization. Consult the manufacturer of the care agents. Do not use any water repellent agents or oils impermeable to steam.
- When using ultrasonic devices, care equipment for handpieces and washer-disinfectors, comply with the manufacturer's reprocessing instructions.



NOTICE

The presence of residual disinfection and cleaning fluids results in corrosion.

This could result in increased maintenance requirements and a restriction of the steam sterilizer function.

Reprocessing textiles



WARNING

The incorrect reprocessing of textiles, e.g. a textile package can prevent steam penetration or produce poor drying results.

The textiles could not be sterilized.

Comply with the following points when reprocessing textiles and putting the textiles in sterile containers:

- Comply with both the manufacturer's instructions of the textiles regarding reprocessing and sterilization as well as the relevant standards and directives (in Germany e.g. from the ▶RKI and ▶DGSV).
- Arrange the folds in the textiles parallel to each other.
- Stack textiles vertically wherever possible and not too closely together in the sterile container. This enables the development of flow channels.
- If textile packages do not remain together, wrap the textiles in sterilization paper.
- Only ever sterilize dry textiles.
- The textiles may not be permitted to come into direct contact with the sterilization chamber; otherwise they will become saturated with ▶condensate.

Loading the steam sterilizer

Effective sterilization and good drying is only possible if the steam sterilizer has been loaded correctly.

Ensure the following during loading:

- Insert trays or sterile containers in the sterilization chamber only with their appropriate mount.

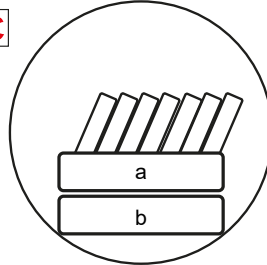
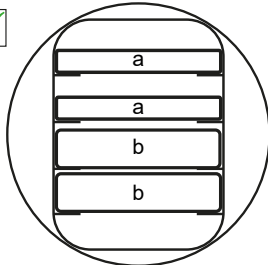

- a Tray
- b Sterile container

- Slide the mount into the sterilization chamber to its fullest extent. The holder must engage audibly and noticeably in the spring clip.

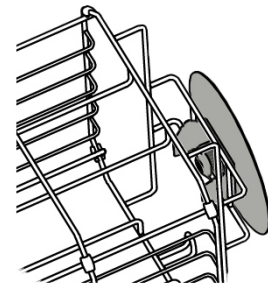

- Wherever possible, ensure the separate sterilization of textiles and instruments in separate sterile containers or sterilization packages. This leads to better drying results.
- The use of paper tray inserts can result in poor drying results.
- Use perforated trays such as those from MELAG. Only in this way can condensate drain off. Non-perforated bases or half-shells for holding the load lead to poor drying results.

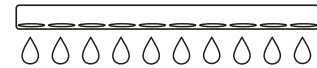

Packaging

Only ever use packaging materials and systems (sterile barrier systems) which fulfil the standard EN ISO 11607-1. The correct use of suitable packaging is important in achieving successful sterilization results. You can use re-usable rigid packaging systems or soft packaging such as transparent sterilization package, paper pouches, sterilization paper, textiles or fleece.

Closed sterile containers



WARNING

Risk of contamination due to insufficient steam penetration or poor drying.

- Use only suitable sterile containers.
- Do not cover the perforations when stacking the sterile containers so that the condensate can drain off.

Please comply with the following when using closed sterile containers:

- Use aluminium sterile containers. Aluminium retains and conducts heat and thus accelerates drying.
- Closed sterile containers must be either perforated or have a valve on at least one side. MELAG sterile containers, e.g. MELAstore Box, fulfil the requirements for successful sterilization and drying.

- Wherever possible, ensure that sterile containers are only stacked on top of those of identical size, so that the condensate can run down their sides.
- Ensure that the perforations are not covered when stacking the sterile containers.

Tip: MELAG sterile containers fulfil the requirements of EN 868-8 for successful sterilization and drying. They have a perforated lid and base and are fitted with disposable paper filters.

Soft sterilization packaging

► **Soft sterilization packages** can be used in both sterile containers and on trays. Please comply with the following when using soft sterilization packages e.g. MELAfol:

- Arrange transparent sterilization packages on edge and close together. If this is not possible, place them with the paper side facing downwards.
- Do not place multiple soft sterilization packages flat on top of each other on a tray or in a container.
- When loading the steam sterilizer, make sure that either the film or paper sides of different pouches are facing each other.
- If the seal seam tears during sterilization, this could be caused by the choice of undersized packaging. Pack the instruments with larger packaging and perform sterilization again.
- Should the seal seam tear during sterilization despite sufficient bag size, adjust the sealing temperature on the sealing device or make a double seam.

Multiple wrapping

The device uses a fractionated vacuum procedure. This permits the use of ► **multiple wrapping**, see [Selecting the program](#) [► page 43].

Mixed loads

Please observe the following when sterilizing ► **mixed loads**:

- Always place textiles at the top
- Sterile containers at the bottom
- Place unwrapped instruments at the bottom
- Place the heaviest loads at the bottom
- Transparent sterilization packages and paper packages on the top. Exception: At the bottom in combination with textiles

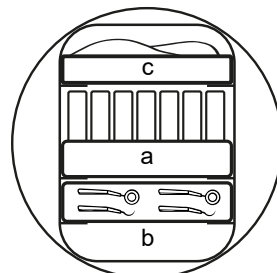
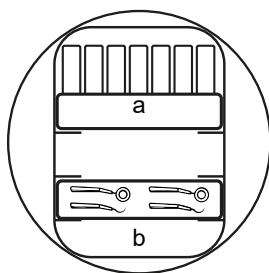

- a Wrappings
- b Heavy loads/instruments
- c Textiles

Loading volumes

Max. weight per component

Load*)	Vacuclave 118	Vacuclave 123
Max. weight per component	2 kg	2 kg

*) For MELAG mounts, trays, sterile containers, see [Accessories and spare parts](#) [► page 93].

Loading patterns can be found in the separate document "User manual Accessories for small steam sterilizers".





Selecting the program

All sterilization programs are displayed in the **Programs** menu. The following tables show you which program you use for which load and which service programs are also available to you.

When selecting the sterilization program, proceed as follows:

- Select the sterilization program based on which products you want to sterilize.
- Select the sterilization program according to whether and how the load is wrapped.
- Observe the permissible max. load quantities.
- Note the temperature resistance of the load.

Overview of sterilization programs

Program	Especially suitable for		Maximum load quantity		Operating time		Drying
			Vacuclave 118	Vacuclave 123	Vacuclave 118 ³⁾	Vacuclave 123 ³⁾	
 Universal B 134°C 2.1 bar 5:30 min	<ul style="list-style-type: none"> ▪ Transmission instruments ▪ Products with narrow lumen ▪ Simple hollow bodies 	Instruments:					20 min
		▪ single wrapped	4 kg	5 kg	22-27 min	24-31 min	
		▪ Double wrapped	3 kg	4 kg	22-26 min	24-30 min	
		▪ unwrapped	5 kg	6 kg	22-28 min	24-32 min	
		Textiles:					
		▪ Double wrapped	1.8 kg	2 kg	22-32 min	24-37 min	
		Sterile container	5 kg	6 kg	22-35 min	24-38 min	
 Quick B 134°C 2.1 bar 5:30 min	<ul style="list-style-type: none"> ▪ Transmission instruments ▪ Products with narrow lumen ▪ Simple hollow bodies 	Instruments:	1.5 kg		22-25 min	24-27 min	10 min
		▪ single wrapped					
		▪ unwrapped	2.5 kg	3 kg	22-26 min	24-27 min	
		No textiles and sterile containers					
 Quick S 134°C 2.1 bar 3:30 min	<ul style="list-style-type: none"> ▪ Simple solid instruments ▪ Simple hollow bodies 	Instruments:					5 min
		▪ unwrapped	2.5 kg	3 kg	15-18 min	16-20 min	
		No textiles and sterile containers					
 Gentle B 121°C 1.1 bar 20:30 min	<ul style="list-style-type: none"> ▪ Thermo-unstable equipment (e.g. plastic, rubber, textiles) ▪ Products with narrow lumen ▪ Simple hollow bodies 	Instruments:					20 min
		▪ single wrapped	4 kg	5 kg	37-42 min	39-47 min	
		▪ Double wrapped	3 kg	4 kg	37-41 min	39-46 min	
		▪ unwrapped	5 kg	6 kg	37-43 min	39-48 min	
				Textiles:			
		▪ Double wrapped	1.8 kg	2 kg	37-47 min	39-51 min	
		Sterile container	5 kg	6 kg	37-49 min	39-53 min	

³⁾ without drying, with a full load and dependent on the load and set-up conditions (such as e.g. mains voltage)

Program	Especially suitable for		Maximum load quantity		Operating time		Drying
			Vacuclave 118	Vacuclave 123	Vacuclave 118 ³⁾	Vacuclave 123 ³⁾	
 Prion B 134°C 2.1 bar 20:30 min	<ul style="list-style-type: none"> Inactivation of prions (e.g. Creutzfeldt-Jacob) Transmission instruments Products with narrow lumen Simple hollow bodies 	Instruments:					20 min
		▪ single wrapped	4 kg	5 kg	37-42 min	37-48 min	
		▪ Double wrapped	3 kg	4 kg	37-41 min	37-47 min	
		▪ unwrapped	5 kg	6 kg	37-43 min	37-49 min	
		Textiles:					
		▪ Double wrapped	1.8 kg	2 kg	37-47 min	37-51 min	
		Sterile container	5 kg	6 kg	37-50 min	37-53 min	

Starting the program

The following must be fulfilled or present:

- ✓ The sterile filter is screwed into the device.
- ✓ The load has been cleaned and disinfected, see [Preparing the load](#) [▶ page 40].
- ✓ The device is loaded correctly, see [Loading the steam sterilizer](#) [▶ page 41].
- ✓ The max. load quantity has not been exceeded, see [Selecting the program](#) [▶ page 43].
- ✓ The date and time are set correctly, see [Date](#) [▶ page 60] and [Time](#) [▶ page 61].

1. In the main menu, press **Programs**.

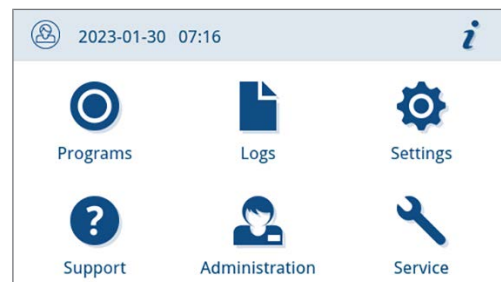

2. Select the program in the menu.



→ The view changes to the program view. This informs you which type of load the program is suitable for before a program start.

3. If desired, activate or deactivate the [Additional drying](#) [▶ page 45].

4. Press **START PROGRAM** in the program view.

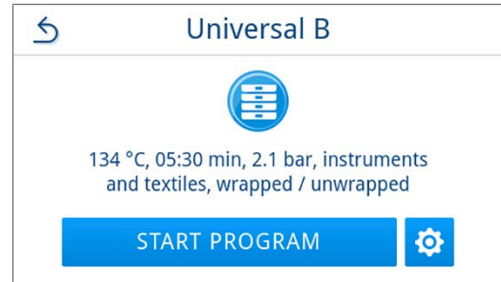

→ When the program starts, the device checks the amount of feed water and the conductivity.

Program options

Additional drying

With correct loading, the program-specific drying times guarantee adequate drying of the **sterile material**. The **Additional drying** option extends the drying time by 50 % to perform difficult drying tasks.

Additional drying is deactivated by default and can be activated before a program start. Activation only applies to this selected program run. The setting for permanent activation can be found in the chapter [Drying](#) [page 71].

Activating additional drying

1. Press  in the program view.



2. Press **OFF/ON**.

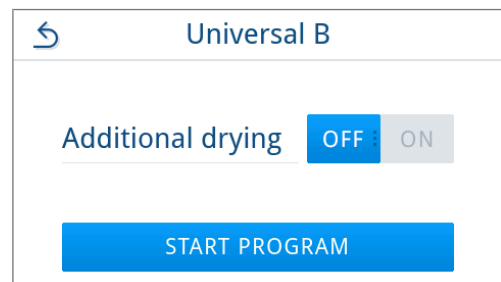

→ The **OFF/ON** button changes to the active status **ON**.

3. Press **START PROGRAM**.

→ The additional drying only applies to the selected program run. It is not permanently activated.

Program in progress

After program start, you can follow the program run on the display. The following values are displayed during the program run:

- ▶ **Program run display:**
 - a) Program parameter
 - b) Program name
 - c) Program phase
 - d) Remaining run time (remaining program duration in minutes)
 - e) Expected end of program

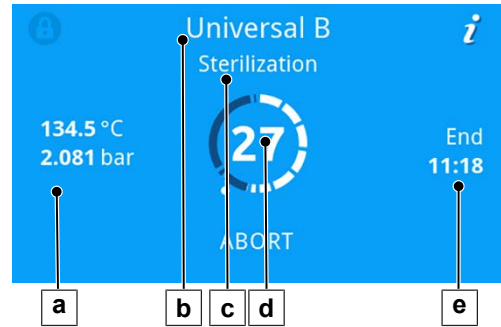

Manual program abort

You can abort the program at any time. If you abort the program before the end of the sterilization phase, the load is **not** sterilized.



WARNING

Danger of infection from early program abort

Aborting a program before the drying phase begins means that the load is unsterile. This endangers the health of your patients and practice team.

- Re-pack the load if necessary.
- Repeat the sterilization of the load.



CAUTION

Danger of scalding from hot steam!

On opening the door, steam and hot water can escape from the sterilization chamber. e.g. if it is necessary to open the door immediately after the end of a program. This could result in scalding.

- Should steam be issued from the rear of the device after its deactivation, wait until the procedure has finished. Wait a further 5 min before opening the door.
- Stand to one side of the door and maintain sufficient distance.
- Allow the sterilization chamber to cool before removing the load.

1. Press **ABORT** to abort the running program.

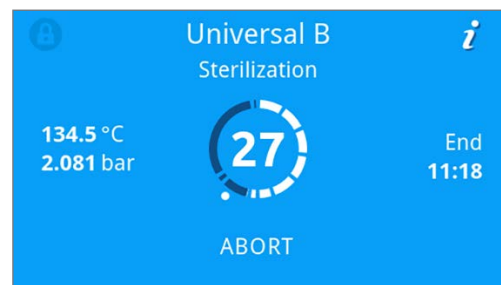

2. Confirm the security query with **YES** and wait until the program abort has been carried out.



➡ The program will be classified as unsuccessful. The load was not sterilized. Both LEDs light up red.

3. Press UNLOCK DOOR.

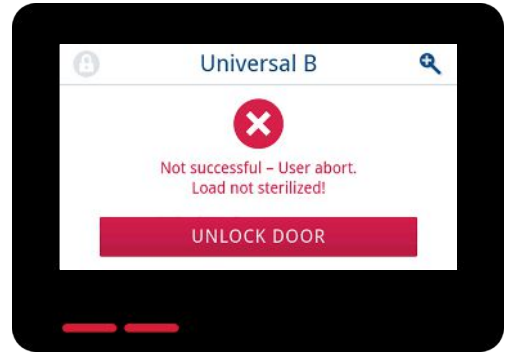

4. To confirm an unsuccessful program run, follow the instruction on the display and press the corresponding button.

In the example view, the A button must be pressed to confirm!

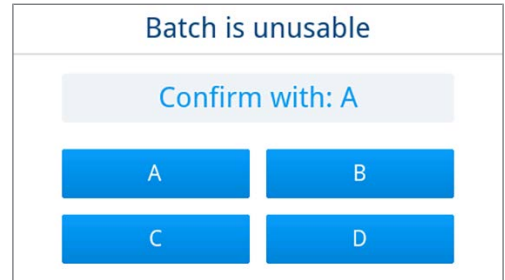

↳ If the entry is incorrect, it must be repeated.

5. Wait for the pressure equalisation.

PLEASE NOTE: If the pressure equalisation is not yet finished, a corresponding note is shown on the display.

6. Open the door carefully and not forcibly.



↳ The load is **not** sterile. If necessary, wrap the load again and repeat the program.

Ending the program prematurely

You can end the program prematurely. If you abort the program before the end of the drying phase, the load is not completely dried and should be used immediately.

The following must be fulfilled or present:

- ✓ The sterilization program is in the drying phase.

1. Press **END** to end the current program.



2. Confirm the security query with **YES**.

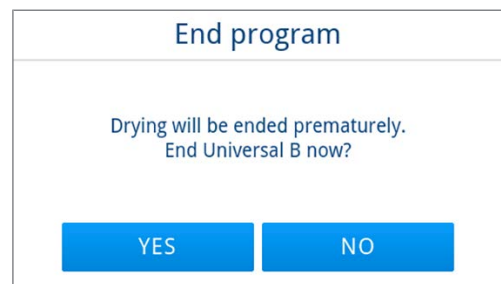

3. Wait until the program has finished.
 - ➔ After successful completion of the program, the status LED (left LED) lights up green and an acoustic signal sounds once.

4. Press **UNLOCK DOOR**.

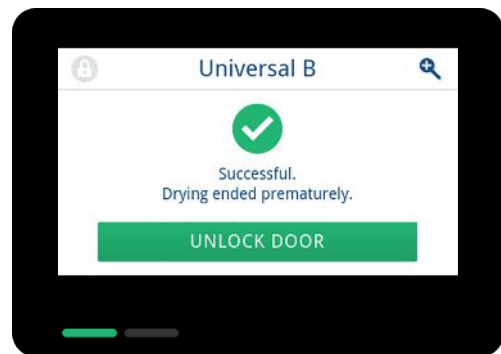

5. Open the door carefully and not forcibly.



Program is ended

Program successful

If the program was successful, the corresponding message will be issued on the display. The status LED (left LED) below the display lights up green and an acoustic signal sounds once.

1. Press UNLOCK DOOR.

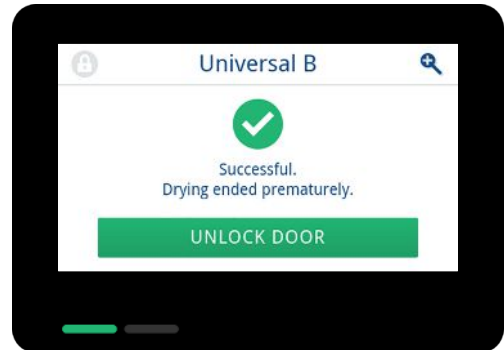

2. Open the door carefully and not forcibly.



If automatic log output after the end of the program is activated in the **Settings** menu (= immediate output), the log of the run program is output to the activated output media after the door is opened.

Program not successful



WARNING

Danger of infection due to non-sterile load!

If the safety LED (right LED) lights up red, the program was not completed successfully. The load was not sterilized.

- Check the display and the two LEDs at the end of each program.
- Read and follow the instructions on the display.
- Re-wrap and repeat the sterilization for the respective load if necessary.

If the program was not successful, the corresponding message will be issued on the display. The two LEDs below the display light up red and an acoustic signal sounds three times.

1. Press UNLOCK DOOR.

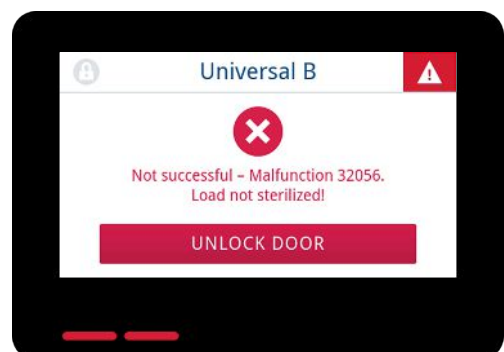

- To confirm an unsuccessful program run, follow the instruction on the display and press the corresponding button.

In the example view, the A button must be pressed to confirm!

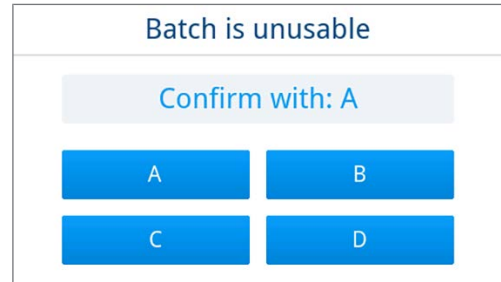

➔ If the entry is incorrect, the entry must be repeated.

- Open the door carefully and not forcibly.



➔ The load was **not** sterilized. If necessary, wrap the load again and repeat the program.

If automatic log output after the end of the program is activated in the **Settings** menu (= immediate output), the log of the run program is output to the activated output media after the door is opened.

Removing the sterile material



CAUTION

Danger of burns from hot loads.

- Use a tray lifter or heat protection gloves.



CAUTION

Unsterile instruments resulting from damaged or burst packaging. This endangers the health of your patients and practice team.

- Should the packaging be damaged or have burst after sterilization, wrap the load again and re-sterilize it.

If you remove the **sterile material** from the device directly after the end of the program, it is possible that the instruments can be partially damp. According to the Arbeitskreis für Instrumentenaufbereitung (▶AKI), single drops of water (no puddles) that dry off within 15 min are considered tolerable residual moisture in practice.

Comply with the following specifications when removing the sterile material:

- Never use force to open the door. This could damage the device or result in the emission of hot steam.
- Hold the mount level when removing it from the device. Otherwise, the load could slide off.
- Hold the tray level when removing it from the steam sterilizer. Otherwise, the load could slide off.
- When removing the load from the device separately, ensure that the mount does not slide out unintended.
- Use a tray lifter or suitable protective gloves to remove the tray.
- Never touch the sterile material, the sterilization chamber, the mount or the inside of the door with bare hands. The components are hot.
- Check the packaging of the sterile material for damage when removing it from the device. Should the packaging be damaged, re-pack the load and re-sterilize it.
- Make sure that the mount is fixed in the spring clip, see [Load mount](#) ▶ page 18].

Storing sterile material

The maximum storage time is dependent on the packaging and the storage conditions. Please observe the regulatory requirements for the storage period of [sterile materials](#) (in Germany e.g. [DIN 58953](#), Part 8 or the [DGSV](#) guidelines) as well as the following listed criteria:

- Follow the manufacturer's instructions on the packaging, e.g. when setting the storage period when printing labels.
- Comply with the maximum storage duration in accordance with the packaging type. Comply with the manufacturer's information on the packaging.
- Store the sterile material in a dust-protected environment e.g. in a closed instrument cabinet.
- Store the sterile material in an environment protected against moisture.
- Store the sterile material in an environment protected against excess temperature variations.

10 Logging

Batch documentation

The batch documentation serves as proof of the successful conclusion of the program and represents an obligatory part of quality assurance. The device internal log memory saves such data as the program type, ▶batch and process parameters of all the programs completed.

To obtain the batch documentation, you can output the internal log memory and transfer its data to various output media. This can be performed immediately at the end of every program or at a later point, such as at the end of the day.

Capacity of the internal log memory

The device is equipped with an internal log memory. This saves all the data regarding the programs automatically. The capacity of the internal log memory is sufficient for 100 logs.

If the internal log memory is full with logs that have not been output, a corresponding message appears on the display. If this is the case, you should provide the specified output medium and output the relevant logs. If the program is continued, the oldest log is automatically overwritten.

MELAG recommends immediately outputting logs automatically, see [Log output](#) [▶ page 66].

Logs menu

The **Logs** menu provides you with the following options:

- Display and output of program logs
- Display and output of fault logs

You can issue logs subsequently and independently of the time of a program end. Before the log output, you can select the output media.

List of logs

All logs of the internal log memory are displayed in a log list depending on the log type. The list is sorted by date (and time), i.e. the newest log is always added at the top of the list. You can navigate up and down within the list.

▶ Program log list:

- a) Program
- b) Date
- c) Total batch
- d) Program result (successful/unsuccessful)
- e) Log output status (dot = log not output)

Program	Date	Batch	New
Quick B	2023-05-03	00014	✓ ●
Quick S	2023-04-27	00013	✓ ●
Quick B	2023-04-27	00012	✗ ●
Quick S	2023-04-27	00011	✗ ●

Legend: a) Program, b) Date, c) Total batch, d) Program result (successful/unsuccessful), e) Log output status (dot = log not output)

Subsequent log output

The following must be fulfilled or present:

- ✓ At least one output medium is connected and activated, see [Log output](#) [▶ page 66].

1. In the main menu, press **Logs**.

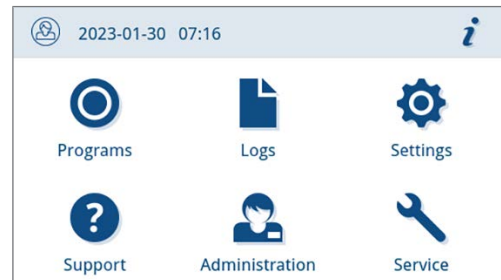

2. Select the log type to view and output single or multiple logs of a log type. To output all logs stored on the device, use the **Output all** function in the log menu.

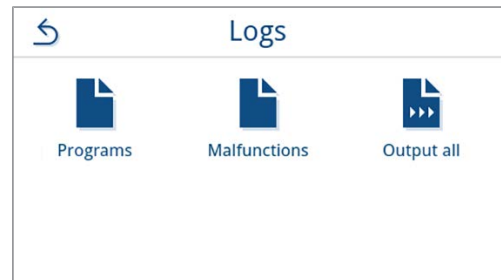

3. Press **▶▶▶** to output several logs of one log type. You can choose to output either the last log, the new logs that have not yet been output or all logs.

Alternatively, you can select a log in the log list to open its log preview and output it.

The example view shows the log list of the log type Programs.

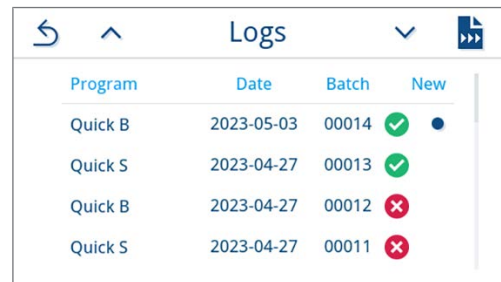

4. Press **OUTPUT LOG** within the log preview.

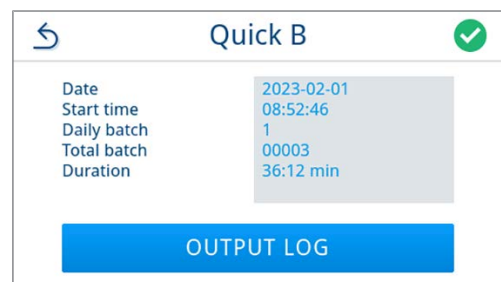

5. Activate the output medium (multiple selection possible) and press **^** or **v** if applicable to have further output media (if available) displayed in the list.

At the end of the list, press **START**.

Press **ABORT** to cancel the process and return to the respective view from which the log output was called.

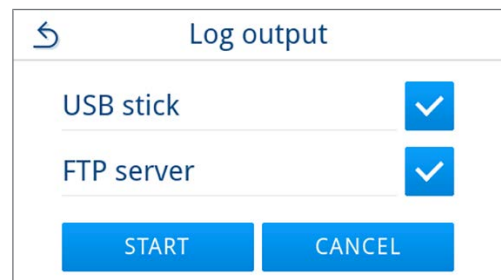

6. Follow the progress of the log output on the display.

If the log output was not executed or not completed by pressing **ABORT**, an unsuccessful/incomplete output result is displayed. This contains the individual output result as a symbol for each output medium.

NOTICE! If the USB stick is removed prematurely or handled improperly, data loss, damage to the USB stick, the device and/or the software may occur!

- a) Number of logs output
- b) Output medium symbol

Example view with selected output media (USB stick, FTP server).

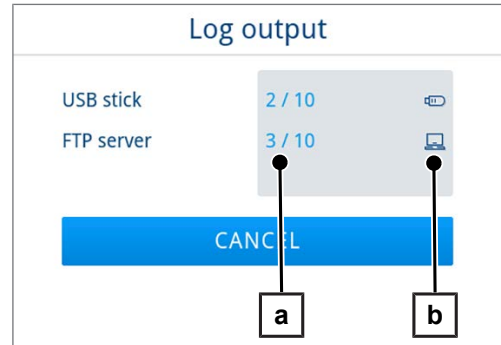

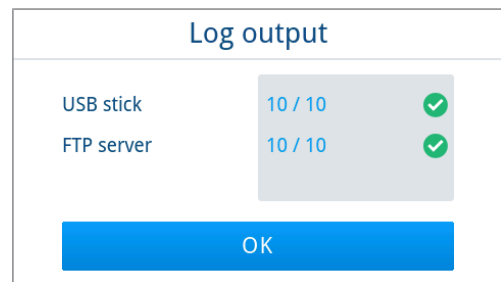

7. The result (successful/unsuccessful) is displayed after the log output. Press **OK** to confirm the result.



Output media

You are able to output and archive the logs of the completed programs on the following output media:

Symbol	Output medium	Description
	FTP server	Output to an FTP server
	USB stick (display and rear of the device)	Storage on a USB stick
	MELAt race	Output to MELAt race



PLEASE NOTE

You can only connect one USB storage medium.

Displaying logs on the computer

The log files are generated in HTML format and can be displayed and printed on the computer with a web browser or in MELAtrace.

The program logs contain a legend entry for each line. The program logs contain graphic data and can be displayed as graphic logs in MELAtrace.



010	File name	2023-02-01_00003_20211230903_QPB_OK_20220920003	010	File name of the log
020	Device type	Vacuolare 123	020	Device type
030	Program name	Quick II	030	Program name
035	Program type	134 °C stopped	035	Program type
040	Date	2023-02-01	040	Creation date of the log
045	Daily / total batch	01 / 00003	045	Daily batch number and total batch number
070	Program result	Program successfully completed	070	Program result
141	Sterilization temperature	135.4 +/-0.14/-0.46 °C	141	Sterilization temperature with max. deviation
143	Sterilization pressure	2.16 +/-0.01/-0.04 bar	143	Sterilization pressure with max. deviation
144	Plateau time	5 min 30 s	144	Sterilization time
150	Conductivity	11.3 µS/cm	150	Conductivity of the feed water
155	Start time	08:52:46	155	Time at program start
156	End time	09:28:58 (36:12 min)	156	Time at program end and program duration
160	Device serial number	20211230903	160	Serial number of the device

Step	Start [m:s]	End [m:s]	Duration [m:s]	P [mbar]	T [°C]	
Program start						
SP5	00:00	00:00	00:00	994	26.9	Program start
Fractonation 1 Evacuation						
SF12	00:00	01:30	01:30	250	23.1	Fractonation 1 Evacuation
Fractonation 1 Pressure increase						
SF13	01:50	05:39	03:49	1900	114.4	Fractonation 1 Pressure increase
Fractonation 2 Outflow						
SF21	05:39	05:55	00:16	1300	106.4	Fractonation 2 Outflow
Fractonation 2 Evacuation						
SF22	05:55	06:58	01:03	320	71.5	Fractonation 2 Evacuation
Fractonation 2 Pressure increase						
SF23	06:58	09:19	02:21	1900	118.5	Fractonation 2 Pressure increase
Fractonation 3 Outflow						
SF31	09:19	09:39	00:20	1599	107.9	Fractonation 3 Outflow
Fractonation 3 Evacuation						
SF32	09:39	10:47	01:08	320	71.5	Fractonation 3 Evacuation
Fractonation 3 Pressure increase						
SF33	10:47	12:51	02:04	1900	118.5	Fractonation 3 Pressure increase
Fractonation 4 Outflow						
SF41	12:51	13:11	00:20	1300	107.9	Fractonation 4 Outflow
Fractonation 4 Evacuation						
SF42	13:11	13:22	00:11	999	100.8	Fractonation 4 Evacuation
Fractonation 4 Pressure increase						
SF43	13:22	14:21	00:59	1850	117.7	Fractonation 4 Pressure increase

11 Function checks

Service programs

Overview of service programs

Program		Use/function
Vacuum test		For measuring the leakage rate, test with a dry and cold device (without load) Vacuum test chamber: <ul style="list-style-type: none"> ▪ Measurement of the leakage rate in the chamber Vacuum test cooler: <ul style="list-style-type: none"> ▪ Measurement of the leakage rate in the chamber and in the cooler Vacuum test pump: <ul style="list-style-type: none"> ▪ Measurement of the leakage rate in the chamber, in the cooler and in the vacuum pump
B&D/Helix test		Steam penetration test with special test package or PCD test (e.g. Helix test body; available from specialist dealers)

Vacuum test

The device can be checked for leakages in the steam system using the **vacuum** test. This determines the leakage rate at the same time.

Perform a vacuum test in the following circumstances:

- Once a week in routine operation
- During commissioning
- Following longer operating pauses
- In the case of a corresponding malfunction (e.g. in the vacuum system)



PLEASE NOTE

Perform the vacuum test with the device in a cold and dry state.

1. Switch on the device.
2. Select **Vacuum test chamber** in the **Programs** menu.

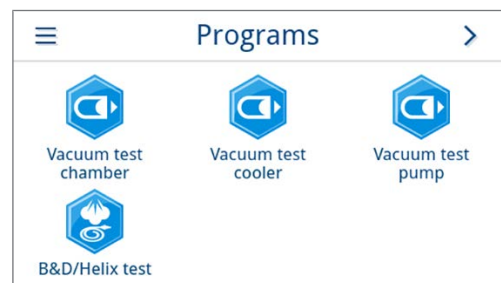

3. Press **START PROGRAM**.

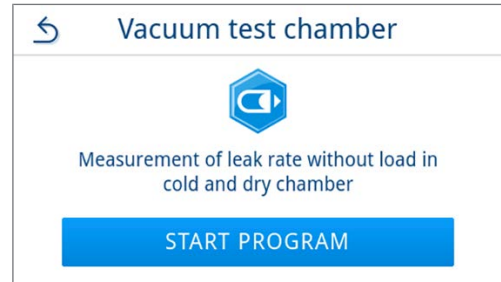

4. Wait until the vacuum test has finished. During the vacuum test, the evacuation pressure, the temperature and the expected end of the vacuum test are shown on the display.

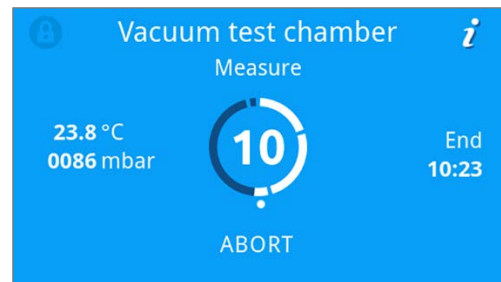

5. The sterilization chamber is ventilated after the end of the measuring time. Then the message will be shown on the display with an indication of the leakage rate. After successful completion of the program, the device status LED (left LED) lights up green and an acoustic signal sounds once.

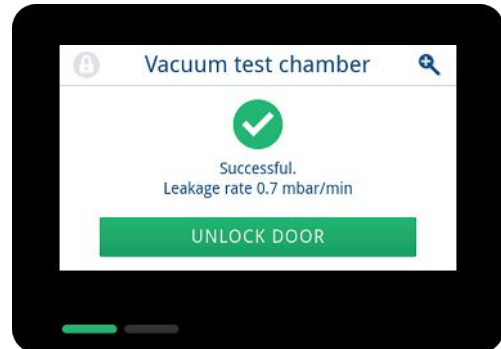

6. Should the leakage rate be too high i.e. over 1.3 mbar, a corresponding message will be issued on the display. Both LEDs light up red. Repeat the vacuum test when the sterilization chamber has cooled down again or contact the authorised technician.

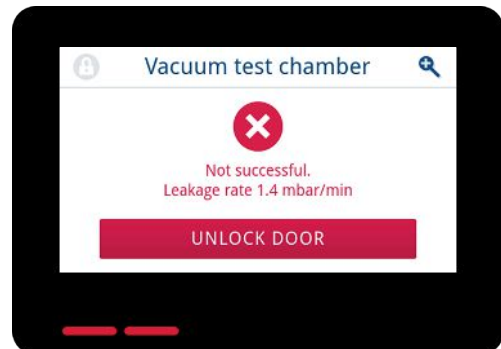

Steam penetration test

The Bowie & Dick test / Helix test serves the verification of the steam penetration of porous materials such as textiles. You can perform a routine function check for proof of steam penetration.

Specialist stockists provide various test systems for the Bowie & Dick test/Helix test. Perform the test according to the test system manufacturer's specifications.

The following must be fulfilled or present:

- ✓ There is a new test system.
- ✓ The sterilization chamber is empty.
- 1. Place the test system in the sterilization chamber according to the manufacturer's instructions.
- 2. Close the door.
- 3. Select the program **B&D/Helix test** in the **Programs** menu.

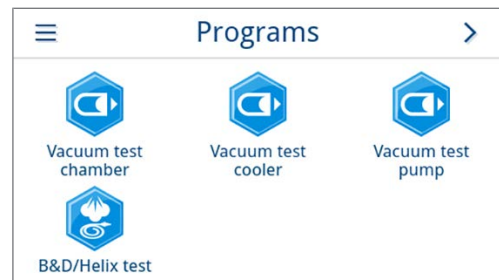

- 4. Press **START PROGRAM**.



12 Settings

Parameters such as language, date, drying etc. can be set in the submenus of the **Settings** menu.

1. In the main menu, press **Settings**.

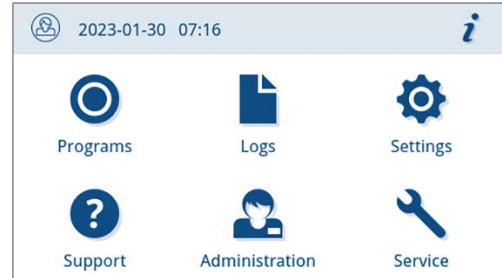

2. Make settings in the corresponding submenus.

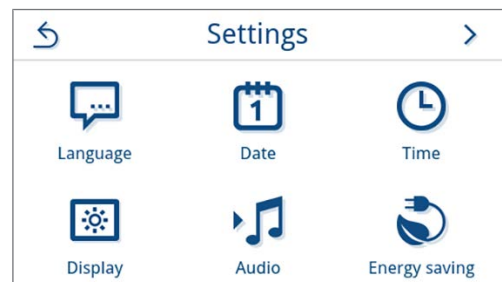

➔ After saving, settings are immediately applied and the view changes from the respective submenu back to the **Settings** menu.

➔ It is not necessary to restart the device.

Discarding changed settings

1. Press  without saving in the header area of the respective submenu to cancel a selection or entry made.



2. Select **YES**.

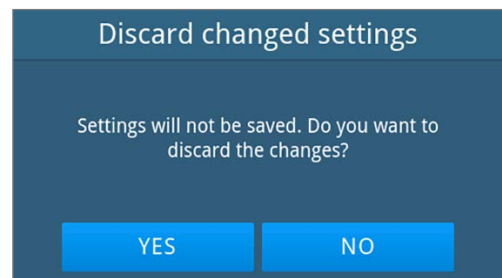

➔ The view changes from the respective submenu back to the **Settings** menu.

➔ If settings are cancelled before saving, the previous parameters remain unchanged.

General settings

General settings can be changed by any user.

Language

You can switch between the enabled languages in the Language submenu.

1. Press **Language** in the **Settings** menu.

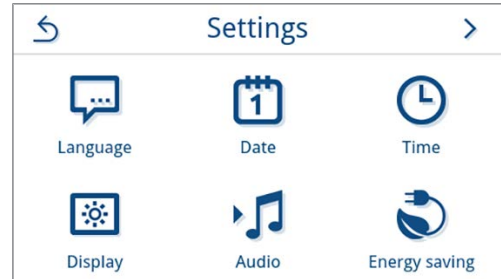

2. Select the desired language using **<** or **>**.
 ↳ After a setting has been changed, the **SAVE** button is active.
3. Confirm with **SAVE**.

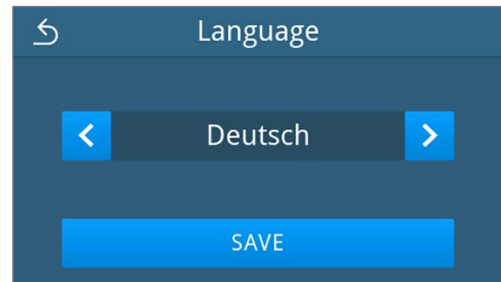

↳ The dialogues on the display and the log texts are changed to the selected language. The view switches back to the **Settings** menu.

Date

The date of the device must be correctly set for proper batch documentation. Set the date as follows:

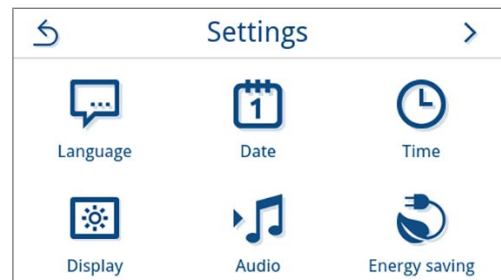

1. Press **Date** in the **Settings** menu.

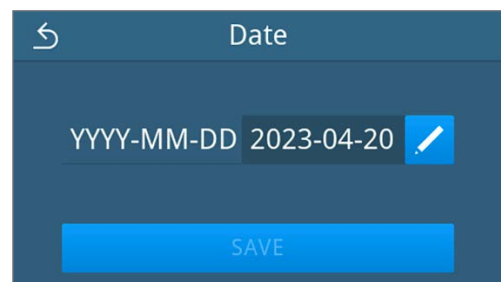

2. Press .



↳ The calendar view opens.

3. Select the correct date in the calendar.
Press  (past) or  (future) to select the month.

TIP: Long press = 1-year increments



➔ After a setting has been changed, the **SAVE** button is active.

4. Press **SAVE**.

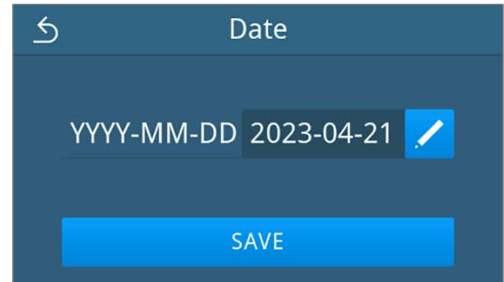

➔ The view switches back to the **Settings** menu.

Time

The time of the device must be correctly set for proper batch documentation. Ensure that you take into account any clock change, as this is not adjusted automatically. Set the time as follows:

1. Press **Time** in the **Settings** menu.

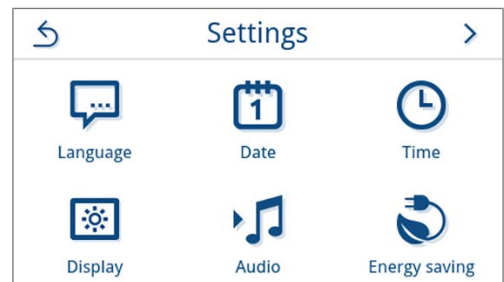

2. Press .

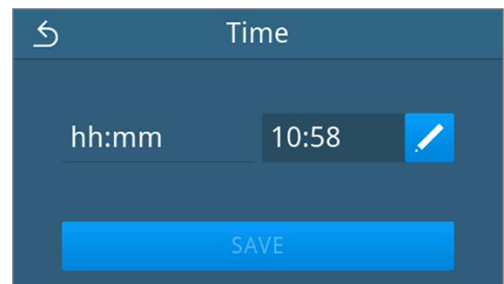

3. Set the correct time using  or  and confirm with **OK**.

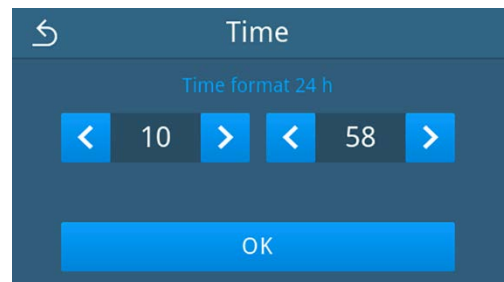

➔ After a setting has been changed, the **SAVE** button is active.

4. Press **SAVE**.

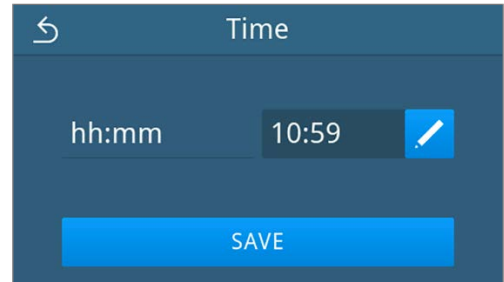

↳ The view switches back to the **Settings** menu.

Display

Individualise the display brightness.

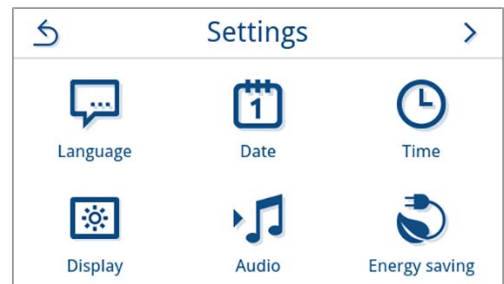

1. Press **Display** in the **Settings** menu.

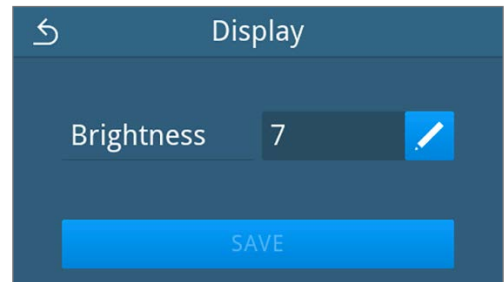

2. Press .



3. Press one of the buttons to change the brightness of the display. The display brightness can be adjusted in several steps.

-  Set the display darker
-  Set the display brighter

The colour bar below the value display gives you an impression of the colour contrast. The brightness is adjusted immediately.

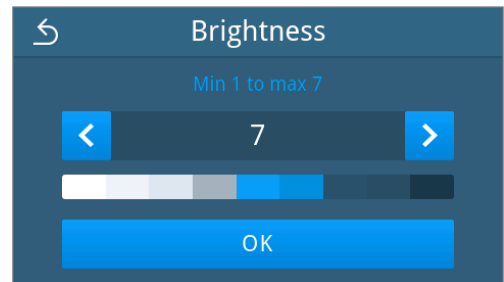

4. Press **OK** to confirm the setting.

↳ After a setting has been changed, the **SAVE** button is active.

5. Press **SAVE**.

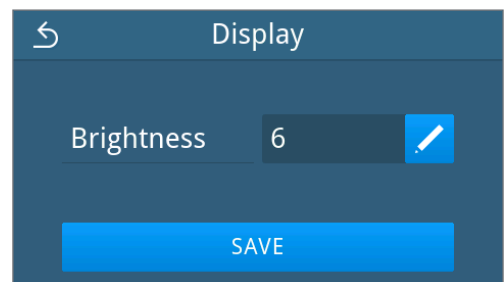

↳ The view switches back to the **Settings** menu.

Audio

You can activate (ON) or deactivate (OFF) the signal tones in the **Audio** submenu. The signal tones are activated by default.

1. Press **Audio** in the **Settings** menu.

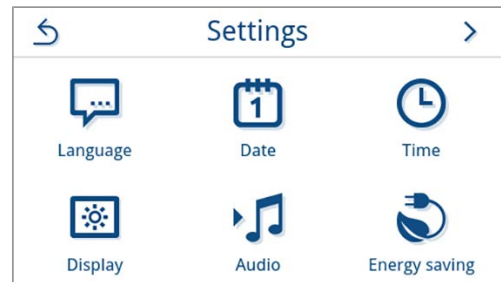

2. Select the desired setting by pressing **OFF/ON**.

↳ After a setting has been changed, the **SAVE** button is active.

3. Press **SAVE**.

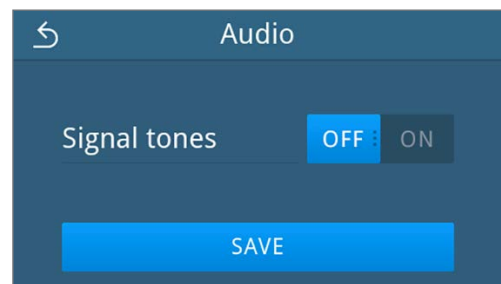

↳ The view switches back to the **Settings** menu.

Energy saving

In energy saving mode you can set an inactive time for the device, after which the preheating and the display are switched off. In the as-delivered condition, energy saving mode is activated after 15 min.

The following functions are deactivated:

- The display is switched off during energy saving mode and is only switched on with a touch.
- When closed, the door is locked and is only unlocked when the display is activated.
- The heater is switched off and is only activated with a program start.

▶ Active energy saving mode is indicated by the permanent display of the  button in the header of the display.

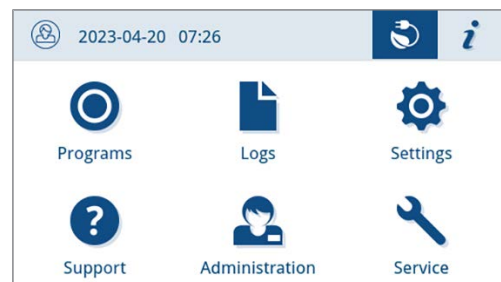

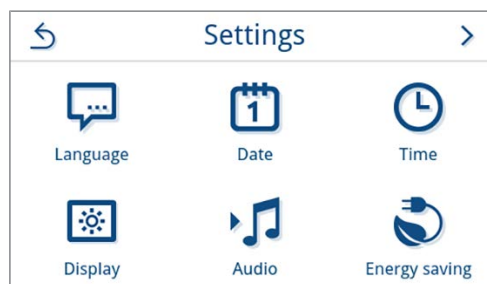

Setting the activation period of energy saving mode

1. Press **Energy saving** in the **Settings** menu.

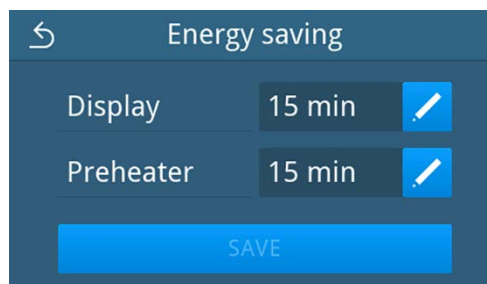

2. In **Display/Preheater**, press .



3. Press  or  to shorten or lengthen the time until energy saving mode is activated.

TIP:

short press = increments of 1
long press = increments of 5

Example view for the display activation period

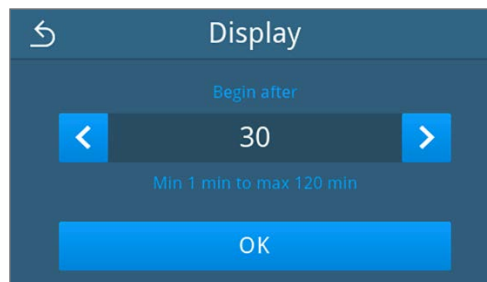

4. Press **OK** to confirm the setting.

➔ After a setting has been changed, the **SAVE** button is active.

5. Press **SAVE**.

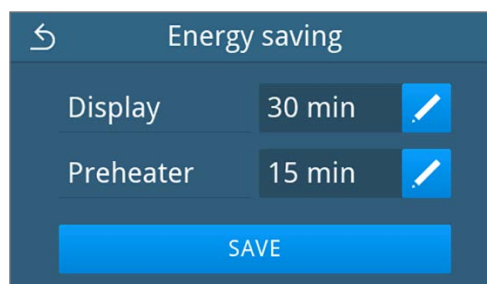

➔ The view switches back to the **Settings** menu.

Manually end active energy saving mode

When a program start occurs, energy saving mode is automatically ended. Alternatively, energy saving mode can also be ended manually as follows:

1. Press the switched off display if necessary.
 - ➔ The display is switched on.

PLEASE NOTE: Activating the display does not end energy saving mode.

2. Press  in the header to open the information on energy saving.

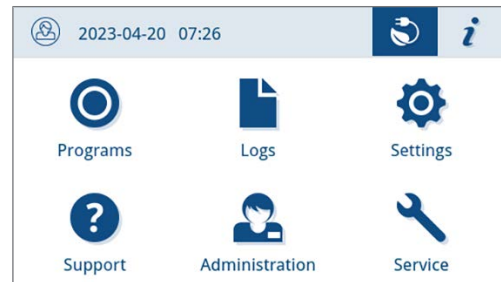

3. Press **END ENERGY SAVING**.

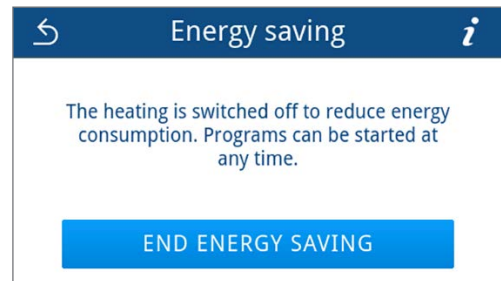

➔ The previous view is displayed again.

Dust filter

You can view the status of the **Dust filter** counter as well as reset it in the dust filter submenu. Replace the dust filter after one year or 1000 cycles at the latest, see [Maintenance intervals](#) [▶ page 77]. For further information on replacing the dust filter, see [Replace dust filter](#) [▶ page 81].

1. Press **Dust filter** in the **Settings** menu.

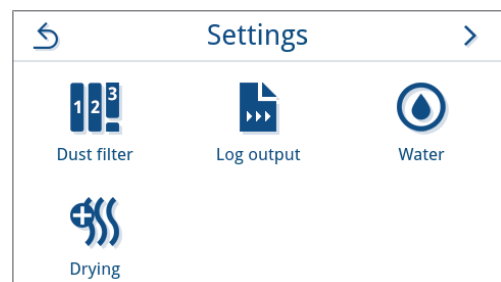

➔ The current counter status is displayed.

2. Press **RESET**.

PLEASE NOTE: If the dust filter counter is set to 0, the counter status cannot be reset. The **SAVE** button is inactive.

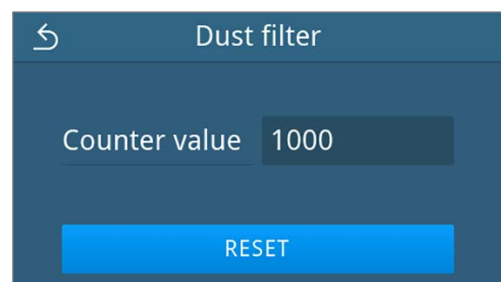

➔ The counter status has been reset to 0.

- Press **SAVE** to accept the counter status.



→ The view switches back to the **Settings** menu.

Log output

In the **Log output** submenu, you can set how the log should be output by default for each output medium.

Manual: The log is output subsequently from the device memory.

Automatic: The log is output automatically at the end of the program.

Deactivated: No log output is possible, even with output medium connected.

Log output on a USB stick

- Press **Log output** in the **Settings** menu.

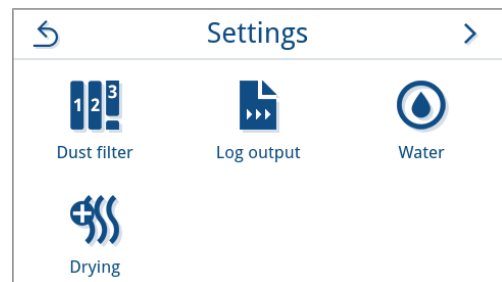

- Press **USB stick**.

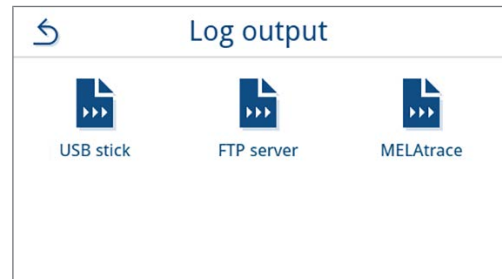

- Select the desired output type by pressing **<** or **>**.

PLEASE NOTE: Automatic output (immediate output) to a USB stick is set by default. An automatic log output of the program/malfunction log is triggered after each program end/malfunction.

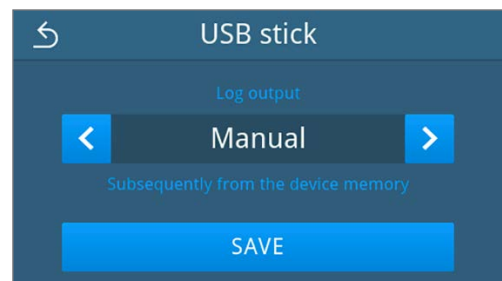

- Press **SAVE**.

→ The selection has been set as default. The view switches back to the **Log output** submenu.

Log output on a FTP server

Please use *MELAG FTP Server* to set up an FTP server. You can find the program in the download centre on our website at www.melag.com/en/service/downloadcenter.

1. Press the **Log output** button in the **Settings** menu.

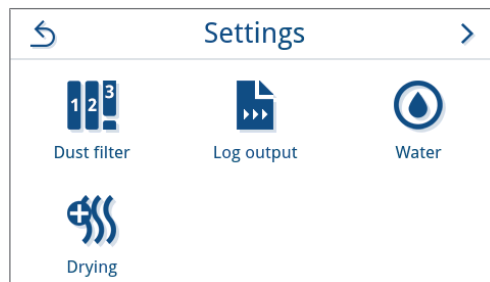

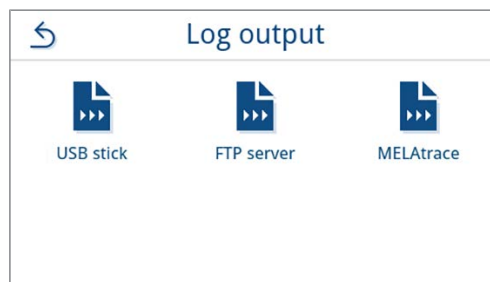

2. Press **FTP server**.



3. Press  next to **Deactivated** to change the output type.

PLEASE NOTE: Automatic output to a FTP server is deactivated by default.



4. Select the desired output type by pressing  or .



 The edited setting is displayed.

5. Select this setting and confirm with **OK**.
6. Set up the FTP server.

Setting up an FTP server

1. Press  next to 0.0.0.0, to set up the FTP server.



2. Enter the IP address and accept the changes by confirming with **OK**.

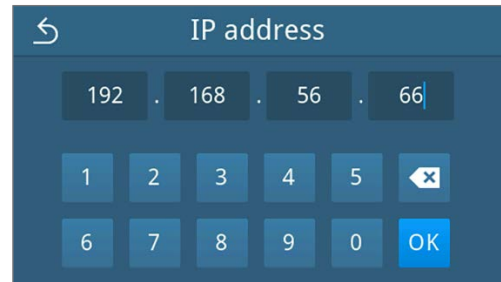

↳ The view for changing the user name is displayed.

3. Enter the user name of the FTP server and accept the changes by confirming with **OK**.



↳ The password entry view is displayed.

4. Enter the password of the FTP server and accept the changes by confirming with **OK**.

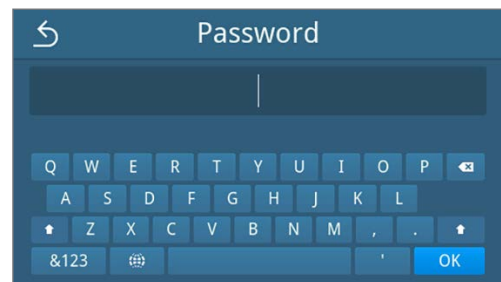

↳ The view for selecting the output type is displayed again.

5. After a setting has been changed, the **TEST** and **SAVE** buttons are active. Press **TEST** to check the connection with the FTP server settings.

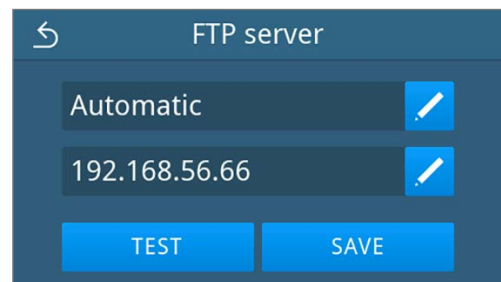

- 6. Confirm with **OK**.
If the connection test fails, check your entries and test again.

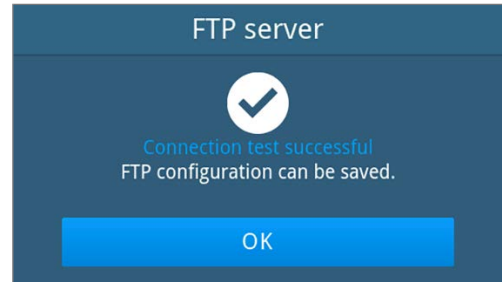

- 7. Press **SAVE**.

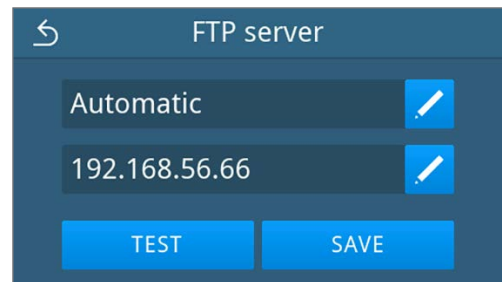

→ The selection has been set as default and the view changes back to the **Log output** submenu.

Log output with MELAtrace

- 1. Press **Log output** in the **Settings** menu.

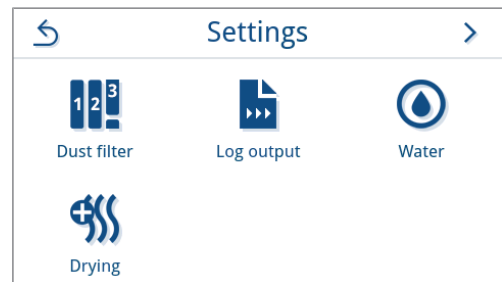

- 2. Press **MELAtrace**.

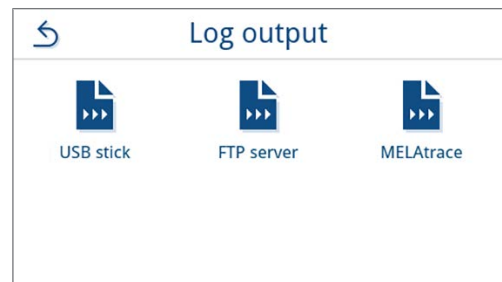

- 3. Select the desired output type by pressing **<** or **>**.
PLEASE NOTE: Automatic output with MELAtrace is deactivated by default.



- 4. Press **SAVE**.
→ The selection has been set as default. The view switches back to the **Log output** submenu.

Water

Select the settings for water management in the **Water** submenu. Water supply and disposal is set to **Manual** by default.

Manual: Water supply and disposal is via the internal storage tank.

Automatic: The water is supplied via a connected water treatment unit (e.g. MELAdem 40/47). The wastewater is automatically disposed of via the wastewater funnel into the building's wastewater installation.



PLEASE NOTE

The change requires an adjustment of the device installation. Note the [Installation examples](#) [▶ page 26].

1. Press **Water** in the **Settings** menu.

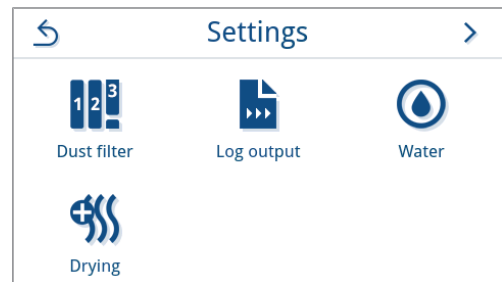

2. Press  the to edit the **Supply**.

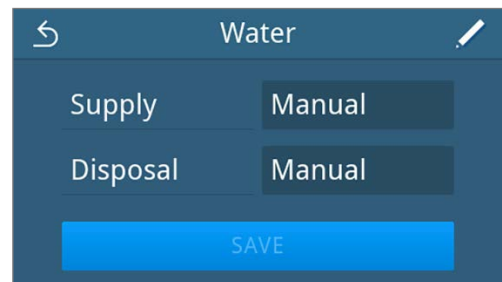

3. Select the type of supply by pressing  or .

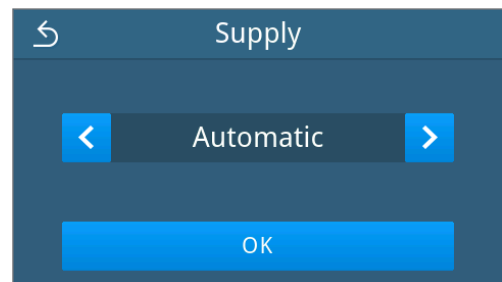

4. Press **OK** to accept the changes.

↳ The view for **Disposal** is displayed.

5. Select the type of disposal by pressing  or .

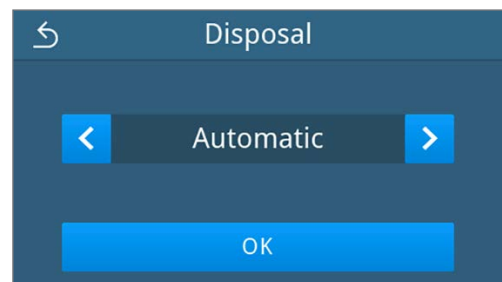

6. Press **OK** to accept the changes.

↳ After a setting has been changed, the **SAVE** button is active.

7. Press **SAVE**.

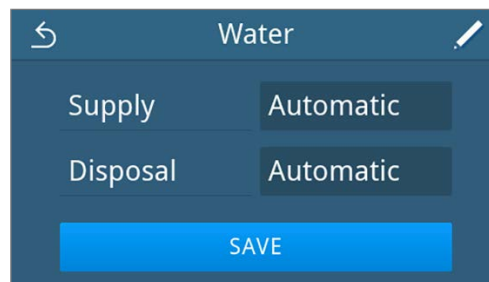

→ The view switches back to the **Settings** menu.

Drying

You have the option of permanently activating or deactivating additional drying in the **Drying** submenu. You have the option to change the preset drying mode once at the program start via [Program options](#) [▶ page 45].

Additional drying is deactivated by default.

If you want to change the global drying setting, proceed as follows:

1. Press **Drying** in the **Settings** menu.

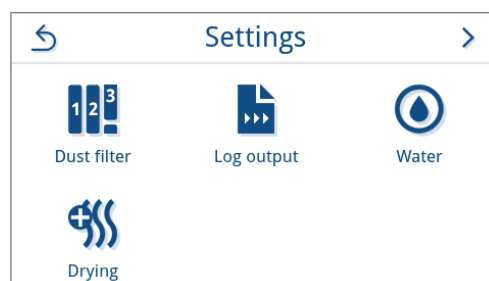

2. Activate or deactivate the desired setting by pressing the **OFF/ON** button.

→ After a setting has been changed, the **SAVE** button is active.

3. Press **SAVE**.

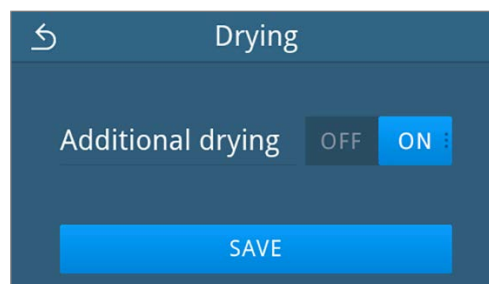

→ The view switches back to the **Settings** menu.

Administrative settings

To make administrative settings, such as changes in user administration, you must log in as an administrator or service technician.

Logging on user role

1. In the main menu, press **Administration**.

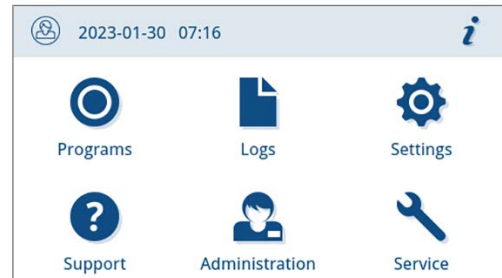

2. Select the desired role, e.g. **Administrator**.

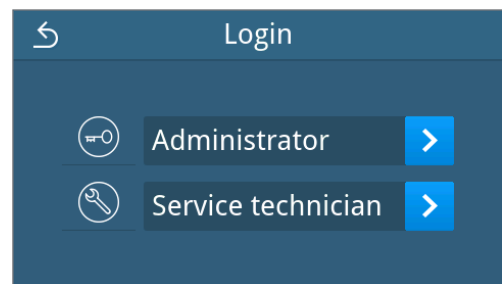

3. Enter the associated PIN.

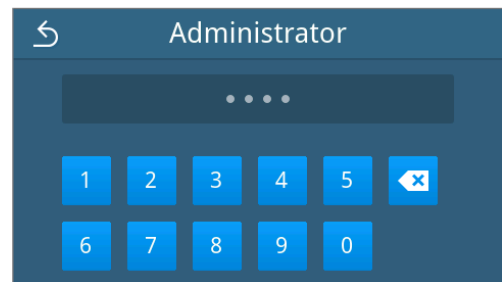

↪ The symbol of the User Role button changes on logging in as a **Service technician**.

↪ Further setting options are now available in the menu.

↪ If the login was successful, the **Administration** menu is displayed.

Logging out as an administrator

The following must be fulfilled or present:

- ✓ You are logged in as administrator and are in the **Administration** menu.

1. To exit the **Administration** menu you must log out of the **Administrator** role.

Press  in the **Administration** menu until the view for logging out as administrator is displayed.

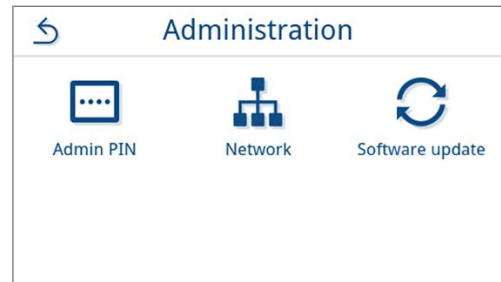

2. Press **LOGOUT**.

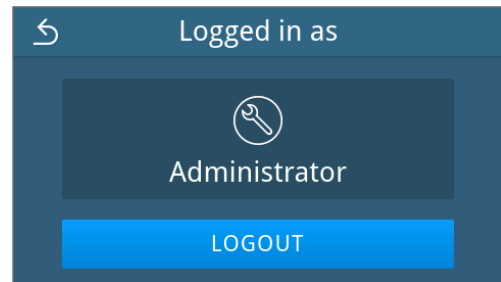

➔ After logging out, the main menu is displayed in the user role "Practice employee".

Admin PIN

When the device is delivered, the admin PIN is set to 1000 by default. MELAG recommends that you change the admin PIN upon commissioning.



PLEASE NOTE

If the changed Admin PIN is lost, contact an authorised technician.

The following must be fulfilled or present:

- ✓ You are logged in as an administrator or service technician, see [Logging on user role](#) [▶ page 72].

1. Press **Admin PIN** in the **Administration** menu.

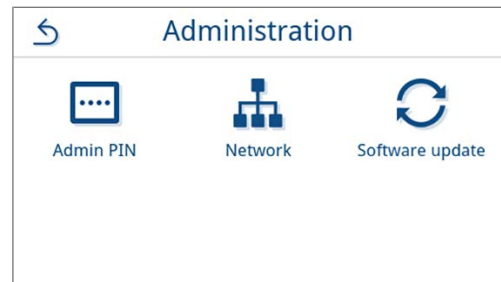

2. Press .

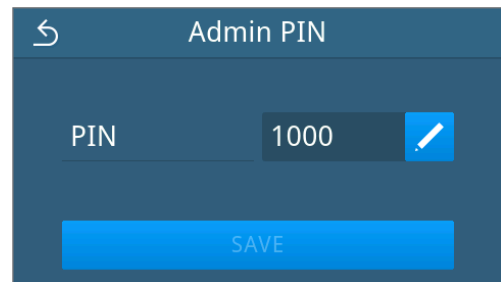

3. Enter the new four-digit PIN and confirm with **OK**.

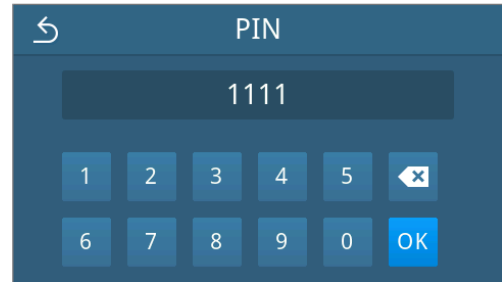

➔ After a setting has been changed, the **SAVE** button is active.

4. Press **SAVE**.

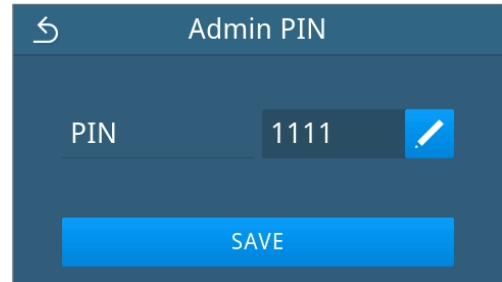

➔ The view switches back to the **Administration** menu.

Network

You can select an automatic configuration via DHCP or enter the required address details manually. DHCP is activated by default.

Manual (Static) entry

The following must be fulfilled or present:

- ✓ You are logged in as an administrator or service technician, see [Logging on user role](#) [▶ page 72].

1. Press **Network** in the **Administration** menu.

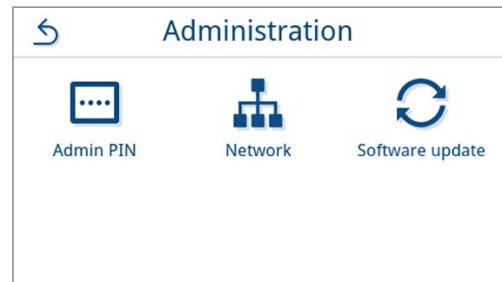

➔ The current network configuration view is displayed.

2. The entries are inserted automatically if the device is integrated in the practice network with a DHCP server. If there is no DHCP server, the entries remain empty.

Press  to edit the network settings.

Example view of a network setting.

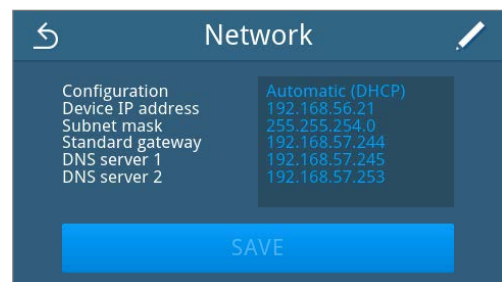

➔ The view for editing the network settings opens.

- Use **<** or **>** to select the setting **Manual (static)** and confirm the selection with **OK**.

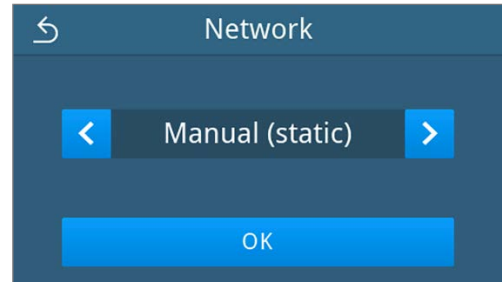

→ The view for editing the IP address is displayed.

- Enter the IP address of your network and confirm the selection with **OK**.

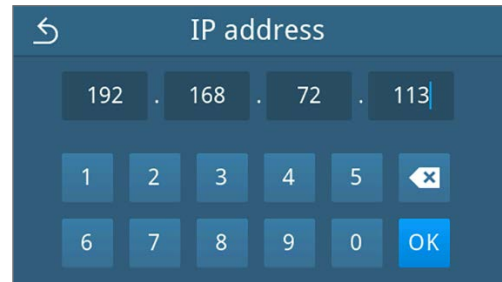

→ The view for editing the subnet mask is displayed.

- Enter the address of the subnet mask of your network and confirm the selection with **OK**.

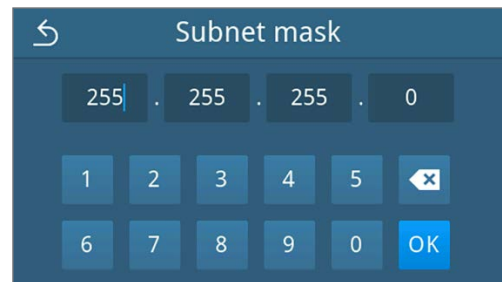

→ The view for editing the default gateway is displayed.

- Enter the address of the default gateway of your network and confirm the selection with **OK**.

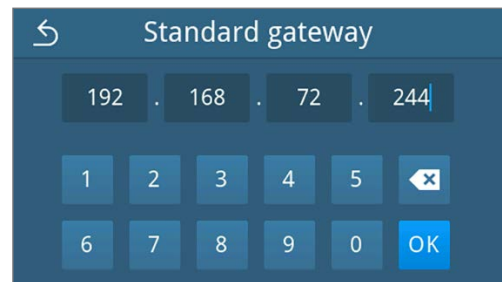

→ The view for editing DNS server 1 is displayed.

- Enter the address of the DNS server 1 of your network and confirm the selection with **OK**.

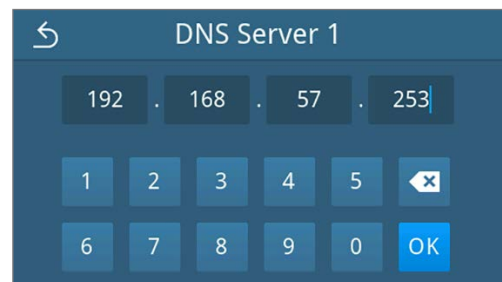

→ The view for editing DNS server 2 is displayed.

- Enter the address of the DNS server 2 of your network and confirm the selection with **OK**.

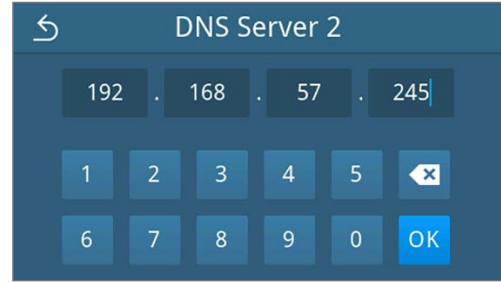

→ The view of edited network settings is displayed.

- Press **SAVE**.



→ The view switches back to the **Administration** menu.

Software update

A software update can only be performed by the administrator or ►authorised technician.



PLEASE NOTE

During a software update, all program and malfunction logs are deleted.

- Check whether all required logs have been output to an output medium.
- Please observe the further information in the separate instruction "Information regarding software update and re-installation". You can find the document in the download centre on our website at www.melag.com/en/service/downloadcenter.

The following must be fulfilled or present:

- ✓ All logs of the internal log memory are output, see [Subsequent log output](#) [► page 53].
- ✓ A USB stick with the current update files is connected in the display area.
- ✓ You are logged in as an administrator or service technician, see [Logging on user role](#) [► page 72].

- Press **Software update** in the **Administration** menu.

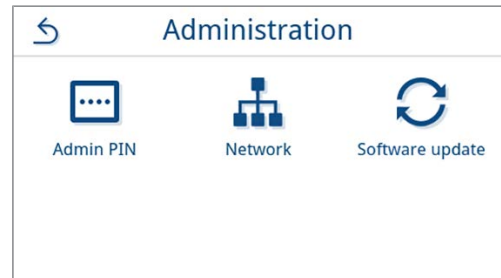

- Insert a USB stick with the installation data into the USB connection on the display.

- Press **NEXT** to perform the software update.

→ During the software update, the device independently performs one or more restarts.

13 Maintenance



PLEASE NOTE

The maintenance work described below can be performed by the user as part of in-house maintenance. All maintenance activities beyond this may only be carried out by an [authorised technician](#).

Maintenance intervals

Interval	Measure	Device component
Every time the feed water tank is filled up	Check the feed water tank (left) for soiling and clean it if necessary before filling	Feed water tank
Daily	Check for soiling, deposits or damage and clean if necessary	Sterilization chamber inc. door seal and sealing face, door lock, mount for the load
	Check the operating media - electricity, feed water, wastewater	Operating media
	Check the output media	USB
Weekly	Chamber vacuum test (in the morning before starting work with a cold and dry device)	Vacuum system
	Replace the feed water completely.	Feed water tank
Every 2 weeks	Clean the wastewater tank (right)	Wastewater tank
Every 3 months	For devices with automatic wastewater disposal:	Wastewater funnel
	Check the wastewater funnel for soiling and scaling	
1x annually or following 1000 cycles	Replace dust filter	Dust filter on the underside of the device
After 24 months or 2000 cycles	Maintenance by the authorised technician working in accordance with the maintenance instructions	Components according to maintenance instructions
As required	Cleaning the surfaces	Housing parts

Cleaning



NOTICE

Inappropriately performed cleaning can lead to the scratching of and damage to surfaces and the development of leaks in sealing surfaces.

This also favours the development of soiling deposits and ▶corrosion in the ▶sterilization chamber.

- Comply with all information regarding cleaning of the part affected.
- Do not use any hard objects for cleaning such as a metal saucepan cleaner or a steel brush.

Sterilization chamber, door gasket, mount, trays

To maintain the value of your device and to avoid persistent contamination and deposits, MELAG recommends weekly cleaning of the surfaces.

PLEASE NOTE: Also follow the additional application instructions for Chamber Protect or, if not available, of the liquid cleaner or spirit.

The following must be fulfilled or present:

- ✓ Chamber Protect (if not available: neutral liquid cleaner or spirits)
 - ✓ The door is open.
 - ✓ The device has been switched off.
 - ✓ The device has been completely cooled.
 - ✓ Trays or sterile containers and the associated mount have been removed from the sterilization chamber.
1. Apply the cleaning agent on a lint-free cloth.
 2. Use the lint-free cloth to spread the cleaning agent uniformly on the surfaces to be cleaned.
PLEASE NOTE: You should not allow cleaning fluid to enter the piping coming from the sterilization chamber.
 3. Allow the cleaning fluid to act and evaporate for a sufficient time. This may take a few minutes.
 4. Wet a new lint-free cloth with plenty of demineralised water.
 5. Wipe the cleaned surfaces thoroughly to remove cleaning residues. Repeat this process as necessary after wringing out the cloth.
NOTICE! Residues of cleaning agents can ignite or cause deposits on the instruments.
 6. Allow the cleaned surfaces to dry completely. This may take a few minutes.
 7. Wipe the cleaned surfaces with a dry, lint-free microfibre cloth.

Housing parts

Where necessary, clean the housing parts with a neutral fluid cleaner or spirit.

Comply with the following specifications when disinfecting the housing parts:

- Use wipe disinfectants and not spray disinfectants. This prevents disinfectant from getting into inaccessible places or ventilation slots.
- Only use alcohol-based surface disinfectants (ethanol or isopropanol) or alcohol-free disinfectants based on quaternary ammonium compounds.
- Do not use disinfectants containing secondary and tertiary alkylamines or butanone.

Internal storage tanks

Carry out regular inspection and cleaning of the internal storage tanks. Observe the [Maintenance intervals](#) [▶ page 77].

Emptying the feed water and wastewater tanks

The following must be fulfilled or present:

- ✓ The device is switched off and has cooled down completely.
 - ✓ A tank with at least 6 l capacity.
1. Open the device door.
 2. Place the collection container in front of the device and the end of the drain hose in the collection container.
 3. Connect the drain hose to the bleed valve for feed water (pos. 1)

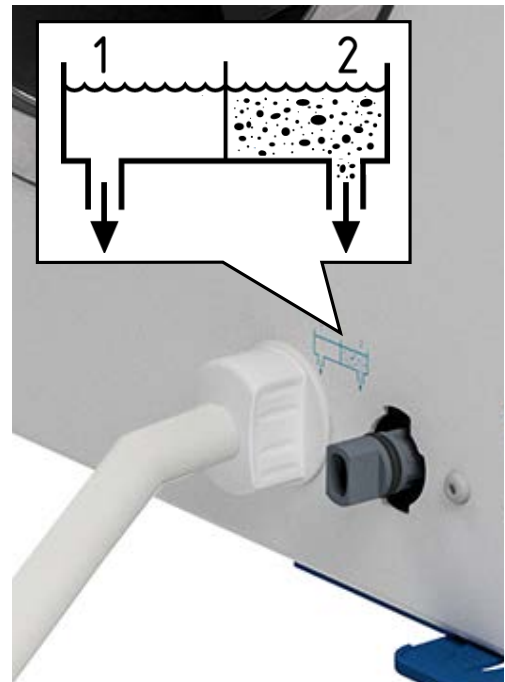

4. Turn the bleed valve with the drain hose anti-clockwise as far as it will go.
 - ↳ The bleed valve is open and the feed water is draining off.
5. Drain the water into the collection container.
6. Turn the bleed valve with the drain hose clockwise as far as it will go.
 - ↳ The bleed valve is closed.
7. Remove the drain hose.
8. Repeat the procedure for the wastewater side (pos. 2).

Cleaning the feed water and wastewater tanks



CAUTION

Danger of scalding from hot wastewater.

While cleaning the wastewater tank, severe scalding may occur due to escaping steam/condensate as well as hot wastewater.

- Never clean the device during a program run.
- Empty the wastewater tank before cleaning.
- Only clean the wastewater tank when the device has cooled down completely.
- Wear suitable protective gloves.

The following must be fulfilled or present:

- ✓ The device has been switched off.
 - ✓ The device has been completely cooled.
 - ✓ The device is completely emptied.
1. Remove the cover of the feed water tank.



2. Remove the tank cover from the device.



3. Remove the cover of the wastewater tank.

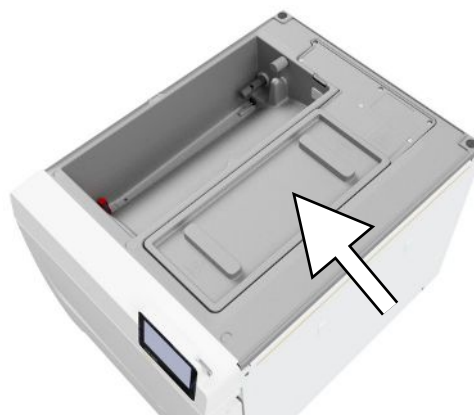

4. Check the feed water tank (pos. b) and waste water tank (pos. c) for contamination. If necessary, clean the feed water tank and then the wastewater tank with a sponge and solvent-free, non-alkaline cleaning agent (e.g. washing-up liquid). MELAG recommends a final cleaning with feed water.

Remove the tank filter (pos. a) from the feed water tank, rinse it first under running water and then with [▶demineralised water](#). Check the cleaning result against the light.

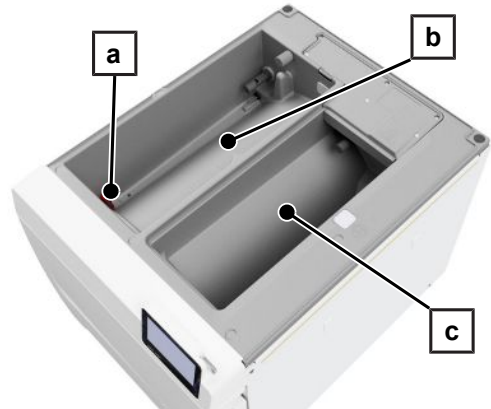

5. Reinsert the tank filter.
6. Replace the cover of the wastewater tank.
7. Hook the tank cover onto the rear of the device and pull the tank cover forward until it clicks into place. Then fold the tank cover onto the device.

PLEASE NOTE: The tank cover must rest evenly on the device on all sides.

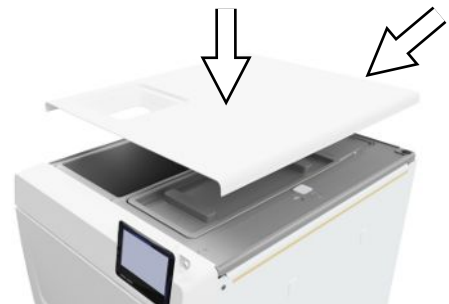

8. Put the feed water tank cover back on the device.

Replace dust filter

The following must be fulfilled or present:

- ✓ A new and dry dust filter.
1. Open the device door.
 2. Press down the centre of the grip and pull out the dust filter.



3. Insert the new dust filter until it snaps into place. The latch nose of the grip must point upwards.
4. Close the device door and reset the counter reading, see [Dust filter](#) [▶ page 65](#)].

Maintenance



NOTICE

Continuing operation beyond the maintenance interval can result in malfunctions in the device!

- Maintenance should only be performed by trained and authorised technicians.
 - Maintain the specified maintenance intervals.
-

Regular maintenance is vital to ensure reliable operation and value retention of the device. All function and safety-relevant components and electrical units must be checked during maintenance and replaced where necessary. Maintenance must be performed in accordance with the pertinent maintenance instructions of the device.

Maintenance work is to be performed regularly after 2000 program cycles but must be performed after 24 months. At the appropriate time, a warning message is shown on the display.

Carry out maintenance with an original maintenance set prepared by MELAG. Only original MELAG spare parts may be used.

14 Pause times

Duration of the operating pause

Duration of the operating pause	Measure
Short pauses between two sterilization processes	<ul style="list-style-type: none"> ▪ Keep the door closed to save energy.
Pauses which last longer than an hour	<ul style="list-style-type: none"> ▪ Switch off the device.
Longer pauses e.g. over night or the weekend	<ul style="list-style-type: none"> ▪ Leave the door ajar to prevent premature wear and the sticking of the door seal. ▪ Switch off the device. ▪ If present, shut off the water inflow of the water treatment unit.
Longer than two weeks	<ul style="list-style-type: none"> ▪ Perform a vacuum test. ▪ After a successful vacuum test, perform an empty sterilization in a reprocessing program. ▪ Empty the internal storage tank.

Decommissioning

When decommissioning the device for a long pause (e.g. due to holiday or planned transport), proceed as follows:

1. Empty the feed water and wastewater tanks, see [Internal storage tanks](#) [▶ page 79]
2. Switch off the device at the power switch.
3. Disconnect the power plug from the socket.
4. Clean the feed water and the wastewater tanks, see [Internal storage tanks](#) [▶ page 79]
5. Close the water inflow if you are using a water treatment unit.

Transport



CAUTION

Danger of injury from incorrect carrying.

Lifting and carrying too heavy a load can result in spinal injury. Failure to comply with these provisions can result in crushing.

- The device should always be carried by two people.
- Comply with the safety regulations issued by your professional association.

Symbols on the packaging



Indicates the temperature limits to which the device can be safely exposed.



Denotes a device that may break or be damaged if handled carelessly.



Indicates a device that must be protected against moisture.



Indicates the upper limit of humidity to which the device can be safely exposed.

On-site transport

To transport the device within a room or floor, proceed as follows:

1. Decommission the device, see [Decommissioning](#) [▶ page 83].
2. When using a water treatment unit, close the water feed and removal the hose connections at the rear of the device.
3. Should you wish to leave the mount and trays or sterile containers in the sterilization chamber during transport, protect the surface of the round blank. To do so, place e.g. some foam or bubble wrap between the round blank and mount.
4. Close the device door before moving the device.

Off-site transport

To transport the device over longer distances, to different floors or for shipping, proceed as follows:

1. Decommission the device, see [Decommissioning](#) [▶ page 83].
2. Pack the device so that it is protected from mechanical hazards (e.g. blows) and moisture.
3. Observe the transport and storage conditions, see [Technical data](#) [▶ page 91].

Fitting the carrying straps



PLEASE NOTE

Have the carrying straps fitted by [authorised technicians](#) only.

1. Remove the four cover caps from the side walls.
2. Hook the carrying straps onto the side wall from below.

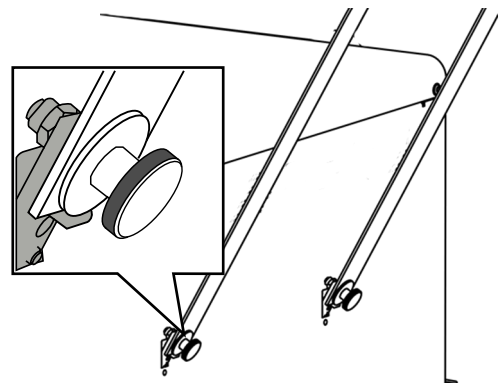

3. Secure the carrying straps to the device with the four knurled screws.

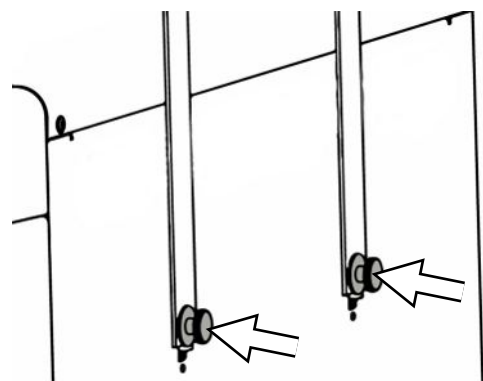

4. Store this cover caps carefully.

Recommissioning after relocation



When recommissioning after changing the location of the device, proceed as for initial commissioning, see [Setup and installation](#) [▶ page 24].

15 Malfunctions

Comply with the following for safe handling:

- Should the device issue the same malfunction message repeatedly, turn off the device and if necessary, inform your stockist.
- The device may only be serviced by ►authorised technicians.

Not all notifications on the display are malfunction messages. Warning and malfunction messages are issued on the display with an event number. This number serves identification purposes.

Type of message	Description
 Warning message	A warning message helps to ensure malfunction-free operation and recognition of undesirable events. React to warning messages quickly to prevent the resulting malfunction.
 Malfunction messages	A malfunction message is issued when it is not possible to ensure safe operation or safety of sterilization. These can appear on the display shortly after switching on the device or during a program run. If a malfunction occurs during a program run, the program will be aborted and considered unsuccessful.



Troubleshooting online

All messages with current descriptions can be found in the Troubleshooting portal on the MELAG website (<https://www.melag.com/en/service/troubleshooting>).



Displaying and reading messages

If there are several messages, the number is shown in the corresponding button in the header.

1. Press  or  to maximise the view of the existing message or to open the message list if there are several messages.

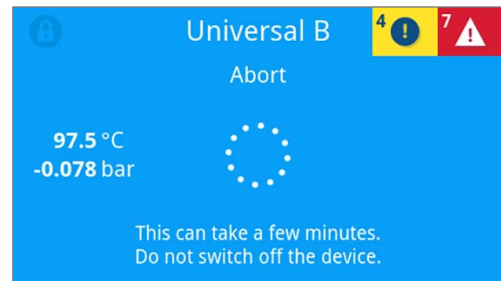

2. Press  in the message list to display the corresponding message.

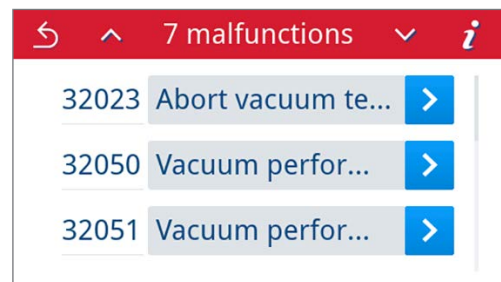

3. The maximised message can be minimised with  or acknowledged by confirming with **OK**.

Acknowledged messages cannot be displayed again.



Before contacting customer services

Follow the instructions that appear on the display in connection with a message.

The following tables indicate possible causes for certain messages/events and the corresponding operating information for their remedy. Should you be unable to find the relevant event, or your efforts do not redress the problem, you can contact your nearest stockist or authorised MELAG customer service provider. Have the following information ready:

- The serial number of your device (see type plate or device status info)
- The event number and/or
- A detailed description of the message

Malfunction logs

In the **Logs > Malfunctions** menu, you can view malfunction logs and output them to a USB stick, see [Subsequent log output](#) [▶ page 53].

Warning and malfunction messages

Event	Possible cause	What you can do
30201	The safety LED is defective.	Please contact the technical service and have the display replaced.
30660 32410	The quality of the feed water is outside the measuring range. a) Water of insufficient quality e.g. tap water was used. When using a MELAG water treatment unit: b) MELAdem 40: The mixed-bed resin cartridge is exhausted. c) MELAdem 47: The mixed-bed resin cartridge, the pre-filter or the activated coal filter is exhausted.	a) Please empty and clean the feed water tank (at the left side) and fill it with water of the required quality (EN 13060, Appendix C). When using a MELAG water treatment unit: b) MELAdem 40: Please replace the mixed-bed resin cartridge according to the applicable user manual. c) MELAdem 47: Please replace the mixed-bed resin cartridge and if necessary, the pre-filter and the activated carbon filter in accordance with the applicable user manual. Empty the pressure tank (if possible until it is half full) and wait until it has been filled again. An empty pressure tank requires approx. 1 h to fill. PLEASE NOTE: The message may also continue to be shown after the filter has been replaced until the water remaining in the storage tank has been consumed.
32002 32024 32050 32051 37014	a) The dust filter is soiled. b) The dust filter is clogged by objects under the filter, making air circulation difficult. c) The surrounding temperature of the steam sterilizer is too hot. The steam sterilizer is installed or the minimum clearances to the surrounding surfaces have not been maintained. d) The steam sterilizer is overloaded or the load has been arranged badly. e) There is packaging residue or other objects in front of the pressure release fittings in the chamber.	a) Please check the dust filter for contamination and replace it if necessary. b) Please check whether there is any paper or objects under the device that obstruct the air circulation and remove them. c) Please ensure sufficient ventilation of the device. Observe the set-up conditions. Conversion cabinets are not recommended. d) Please check the load for compliance with the permissible loading quantities. e) Please check if the pressure release fitting in the sterilization chamber is covered by packaging residue or other objects and remove them.

Event	Possible cause	What you can do
32003 32004	a) The steam sterilizer was switched off at the power switch during a program run. b) The power plug has been disconnected or has not been connected correctly in the socket. c) Power failure in the building supply or the residual current device on-site has been triggered.	a) Never switch off the steam sterilizer at the power switch during a program run. c) Please check whether the power plug is connected, the power cable has suffered damage or a loose contact or loose plug connections is the cause. Plug the power plug back into the mains socket. Make sure that the plug is held in place on the device side by the locking clip. c) Please have the on-site installation checked (e.g. circuit breakers). Test the steam sterilizer on another socket or circuit.
32020	a) The sterile filter is blocked. b) The sterile filter is soiled.	Open the door of the device and check whether: a) The sterile filter is blocked or b) Heavily soiled In these cases, replace the sterile filter.
32021 32022 32023	a) The device is too warm. Residual moisture evaporates and leads to falsification of the result. b) The door seal is damaged. c) The door seal is dirty.	a) Please allow the device to cool down. b) Please check the door seal for visible defects. c) Please clean the door seal with a damp cloth.
32041 32049	There is packaging residue or other objects in front of the pressure release fitting in the sterilization chamber.	Please check if the pressure release fitting in the sterilization chamber is covered by packaging residue or other objects and remove them.
32043 32046 32048	The steam sterilizer is overloaded or the load has been arranged badly.	Please check the load for compliance with the permissible loading quantities. If this occurs repeatedly, contact the technical service.

Event	Possible cause	What you can do
32471	<p>When using a MELAG water treatment unit:</p> <p>a) Kink in the hose installation.</p> <p>b) The water inflow tap is not open or the pressure tank of the MELAdem 47 is closed.</p> <p>c) Residual air is in the feed system of the water treatment unit after initial commissioning or after replacing the mixed-bed resin cartridge.</p> <p>d) The pressure tank of the MELAdem 47 is not sufficiently filled.</p> <p>e) The float switch in the feed water tank (at the left side) is stuck.</p> <p>When using a central water treatment unit:</p> <p>f) The central water supply has been interrupted or the flow pressure is insufficient.</p>	<p>When using a MELAG water treatment unit:</p> <p>a) Please check the hose installation to ensure that it is kink-free and adjust the routing accordingly if necessary.</p> <p>b) Please check whether the water inflow tap for the water treatment unit is open. When using a MELAdem 47, also check whether the tap on the pressure tank is open.</p> <p>c) Please acknowledge the malfunction message and start the program repeatedly until the malfunction message is no longer displayed.</p> <p>d) Please note that after initial commissioning of a MELAdem 47 it takes approx. 1 h until the pressure tank is sufficiently full with water.</p> <p>e) Please check the float switch as follows:</p> <ol style="list-style-type: none"> 1. Please remove the tank cover and the cover of the feed water tank (at the left side). 2. Please move the float in the feed water tank (at the left side) up and down several times to make it move smoothly again. 3. <code>Device status > Digital inputs</code> at <code>S2/S4</code>, the value must change according to the switch position (0 or 1) when the float switches <code>DIN4/DIN5</code> are moved. <p>When using a central water treatment unit:</p> <p>e) Please check whether all inflow valves from the central system to the steam sterilizer are open. If necessary, arrange for an inspection of the flow pressure of the central water treatment unit using a flow pressure gauge (min. 0.5 bar at 5 l/min).</p>
35010	Maintenance interval will expire soon.	Please have the device serviced by an authorised technician .
35020	The dust filter must be replaced soon.	Please replace the dust filter promptly.
36410	USB stick was not recognised.	Please check whether the USB flash drive has been formatted with the FAT file system. Use a different USB flash drive.
36420	More than one USB flash drive has been inserted.	The device supports only one USB flash drive at a time. Please remove all USB flash drives except one.
36415 36425	USB flash drive is not inserted or not inserted correctly.	Please insert a USB flash drive. Please check if the USB flash drive is inserted correctly.
36435	<p>a) The USB flash drive was removed during the writing process.</p> <p>b) The USB flash drive is not connected correctly.</p>	<p>a) Please re-insert the USB flash drive.</p> <p>b) Please check whether the USB flash drive is inserted correctly.</p>
36710	The maximum number of program logs not output was reached. The oldest log will be overwritten the next time the program is run.	Please output the internally stored logs to a USB stick or to your practice network. The log output can also be done automatically; this must be configured in the settings menu.
36720	The USB flash drive does not have enough free space to store the required log data.	Please output the internally stored logs to a USB stick or to your practice network. The log output can also be done automatically; this must be configured in the Settings .

Event	Possible cause	What you can do
36732	a) The network cable has been pulled out or is damaged. b) The network cable is not compatible. c) The computer is not switched on. d) The network connection has not been configured correctly. e) The documentation software on the computer has not been started.	a) Please check whether the network cable is correctly connected or damaged. b) Please check whether a 1:1 network cable is connected. A 1:1 cable must be used for the direct connection between the steam sterilizer and the computer. c) Please switch on the computer. d) Please check the network settings, see Network [▶ page 74]. e) Please start the documentation software.
36733	MELAt race is not connected.	Please check the configuration in the connection menu in MELAt race, see Log output with MELAt race [▶ page 69].
37013	A program was interrupted.	Open the door carefully. Steam and hot condensate may be escaping.
37410	<p>When using the internal storage tank:</p> a) There is not enough feed water (at the left side). b) The float switch in the feed water tank (at the left side) is stuck. <p>When using a MELAG water treatment unit:</p> c) The feed water supply is set to Manual in the device.	<p>When using the internal storage tank:</p> a) Please check whether there is enough feed water in the feed water tank (at the left side) and top up with feed water if necessary. b) Please check the float switch as follows: 1. Please remove the tank cover and the cover of the feed water tank (at the left side). 2. Please move the float in the feed water tank (at the left side) up and down several times to make it move smoothly again. 3. Device status > Digital inputs at S2/S4 , the value must change according to the switch position (0 or 1) when the float switches DIN4/DIN5 are moved. <p>When using a MELAG water treatment unit:</p> c) Please set the feed water supply to Automatic in the Settings menu, see Water [▶ page 70].
37415	Very poor feed water quality. <p>When using the internal storage tank:</p> a) Water of insufficient quality e.g. tap water was used. <p>When using a MELAG water treatment unit:</p> b) MELAdem 40: The mixed-bed resin cartridge is exhausted. c) MELAdem 47: The mixed-bed resin cartridge, the pre-filter or the activated coal filter is exhausted.	<p>When using the internal storage tank:</p> a) Please empty and clean the feed water tank (at the left side) and fill it with water of the required quality (EN 13060, Appendix C). <p>When using a MELAG water treatment unit:</p> b) MELAdem 40: Please replace the mixed-bed resin cartridge according to the applicable user manual. c) MELAdem 47: Please replace the mixed-bed resin cartridge and if necessary, the pre-filter and the activated carbon filter in accordance with the applicable user manual. Empty the pressure tank (if possible until it is half full) and wait until it has been filled again. An empty pressure tank requires approx. 1 hour to fill. <p>PLEASE NOTE: The message may also continue to be shown after the filter has been replaced until the water remaining in the storage tank has been consumed.</p>

Event	Possible cause	What you can do
37460	a) The wastewater tank (at the right side) is full. b) The float switch in the wastewater tank (at the right side) is stuck.	a) Please empty the wastewater tank (at the right side) via the coupling provided. b) Please check the float switch as follows: <ol style="list-style-type: none"> 1. Please remove the tank cover including the cover of the feed water tank (at the left side) and the cover of the waste water tank (at the right side). 2. Please move the float in the wastewater tank (at the right side) up and down several times to make it move smoothly again.
37510	An attempt was made to open the door while the device is still pressurised.	Please wait until the pressure compensation is completed.

16 Technical data

Device type	Vacuclave 118	Vacuclave 123
Device dimensions (H x W x D)	50 x 47 x 64 cm	50 x 47 x 64 cm
Empty weight	48 kg	49 kg
Operating weight	65 kg	68 kg
Floor loading (normal operation)	3.7 kN/m ²	3.9 kN/m ²
Floor loading (pressure resistance test)	3.8 kN/m ²	4.2 kN/m ²
Sterilization chamber		
Diameter	25 cm	25 cm
Depth	35 cm	45 cm
Volume	16.7 l	22.6 l
Electrical connection		
Electricity supply	220-230 V, 50/60 Hz	
Max. voltage range	198-253 V	
Electrical power	2100 W	
Building fuses	Separate power circuit min. 10 A, residual current device with rated residual current = 30 mA	
Overvoltage category	transient overvoltage up to the values of overvoltage category II	
Degree of air pollution (in accordance with EN 61010-1)	category 2	
Length of power cable ⁴⁾	2 m	
Ambient conditions		
Installation location	interior of a building	
Installation surface	level, horizontal and waterproof/sealed surface	
Noise emission	71 dB(A)	
Waste heat (with max. load)	0.9 kWh	
Ambient temperature	5-40 °C (ideal range 16-26 °C)	
Relative humidity	max. 80 % at 31 °C, decreases in a linear fashion up to max. 50 % relative humidity at 40 °C	
Degree of protection (following IEC 60529)	IP20	
Transport and storage conditions	Temperature: -18 to +50 °C, air humidity: < 80%	
Max. altitude	3000 m	
Feed water		
Max. water temperature	35°C	
Water quality	distilled or demineralised feed water in accordance with EN 13060, Appendix C (with central demineralisation system max. conductivity 5 µS/cm)	
Recommended flow pressure	1.5-4.0 bar at 1.4 l/min	
Min. water pressure (static)	2 bar ⁵⁾	
Max. water pressure (static)	8 bar	
Max. water consumption ⁶⁾	approx. 930 ml	approx. 1 l
Water volume (initial commissioning)	min. 1.25 l	
Min. filling volume (internal storage tank, feed water side)	1.25 l	
Volume (internal storage tank, feed water side)	5.3 l (approx. 7 cycles)	

⁴⁾Note the information in the connection diagram.

⁵⁾Optional when using a water treatment unit.

⁶⁾In the Prion-B program with porous full load.

Wastewater	
Max. water temperature	short-term 80 °C ⁷⁾
Volume (internal storage tank, wastewater side)	4.8 l

⁷⁾ Optional: automatically via the one-way drain with the MELAG upgrade kit for the tank drain.

17 Accessories and spare parts

You can obtain the specified articles and an overview of further accessories from your stockist.

Accessories for the device

Category	Article	Art. no.	
		Vacuclave 118	Vacuclave 123
Mounts	Mount A Plus for 5 trays or 3 MELAstore Boxes 100	ME82620	ME82630
Trays	Tray	ME00280	ME00230
Package holder	Package holder (Ø 25 cm)	ME22410	ME22420
MELAstore System	MELAstore Tray 50 (18 x 11.8 x 3 cm)	ME01180	
	MELAstore Tray 100 (27.5 x 17.6 x 3 cm)	ME01181	
	MELAstore Tray 200 (27.5 x 17.6 x 4.3 cm)	ME01182	
	MELAstore Box 100 (31.2 x 19 x 4.6 cm)	ME01191	
	MELAstore Box 200 (31.2 x 19 x 6.5 cm)	ME01192	
Sterilization container with disposable paper filters in accordance with EN 868-8 (depth x width x height)	15K (18 x 12 x 4.5 cm)	ME01151	
	15M (35 x 12 x 4.5 cm)	--	ME01152
	15G (35 x 12 x 8 cm)	--	ME01153
	17K (20 x 14 x 5 cm)	ME01171	
	17M (41 x 14 x 5 cm)	--	ME01172
	17G (41 x 14 x 9 cm)	--	ME01173
	23M (42 x 16 x 6 cm)	--	ME01231
	23G (42 x 16 x 12 cm)	--	ME01232
	28M (32 x 16 x 6 cm)	ME01284	
	28G (32 x 16 x 12 cm)	ME01285	
Films	MELAfol 501	ME00501	
	MELAfol 502	ME00502	
	MELAfol 751	ME00751	
	MELAfol 752	ME00752	
	MELAfol 1001	ME01001	
	MELAfol 1002	ME01002	
	MELAfol 1502	ME01502	
	MELAfol 2002	ME02002	
	MELAfol 2051	ME02051	
	MELAfol 2502	ME02502	

General accessories

Category	Article	Art. no.
Test body system	MELAcontrol Helix consisting of a Helix test body and 250 indicator strips	ME01080
	MELAcontrol Pro consisting of a Helix test body and 40 indicator strips	ME01075
	MELAcontrol Pro refill pack	ME01076
Water treatment	MELAdem 40 ion exchanger	ME01049
	Holder for wall mounting (2 pcs.)	ME15856
	MELAdem 47 reverse osmosis unit	ME01047
For the documentation	USB flash drive	ME19901
Other	Water connection set for Vacuclave 100/300/SteriHero	ME09040
	Water stop	ME01056
	Chamber Protect chamber cleaning set	ME01081

Spare parts

Category	Article	Art. no.
Device	Dust filter	ME82260
	Sterile filter with thread	ME22872
	Feed water filter	ME25070
	Power cable C19 type E+F	ME22331
Mounting	Slide clips for mounts Plus, 10 pcs.	ME81235

18 Technical tables

Feed water quality

Minimum requirements to the feed water following EN 13060, Appendix C

Substance/property	Feed water
Evaporation residue	≤ 10 mg/l
Silicon oxide, SiO ₂	≤ 1 mg/l
Iron	≤ 0.2 mg/l
Cadmium	≤ 0.005 mg/l
Lead	≤ 0.05 mg/l
Traces of heavy metal apart from iron, cadmium, lead	≤ 0.1 mg/l
Chloride	≤ 2 mg/l
Phosphate	≤ 0.5 mg/l
pH value	5 - 7.5
Appearance	≤ colourless, clear, without sediments
Hardness	≤ 0.02 mmol/l

Nominal value tolerances

Step	Universal B		Prion B	Gentle B	Quick B	Quick S	Program phase
	P [mbar _a]	Tolerance					
SP-S	1010		---	---	---	---	Program start
SF12	250	30/-30	◀	◀	◀	◀	Evacuation (Fractionation 1)
SF13	1900	100/-20	◀	◀	◀	1800	Pressure build-up (Fractionation 1)
SF21	1300	20/-50	◀	◀	◀	◀	Flow-off (Fractionation 2)
SF22	320	30/-30	◀	◀	◀	450	Evacuation (Fractionation 2)
SF23	1900	100/-20	◀	◀	◀	1800	Pressure build-up (Fractionation 2)
SF31	1300	20/-50	◀	◀	◀	◀	Flow-off (Fractionation 3)
SF32	320	30/-30	◀	◀	◀	900	Evacuation (Fractionation 3)
SF33	1900	100/-20	◀	◀	◀	1800	Pressure build-up (Fractionation 3)
SF41	1300	20/-50	◀	◀	◀	---	Flow-off (Fractionation 4)
SF42	1000	30/-30	◀	◀	◀	---	Evacuation (Fractionation 4)
SF43	1850	100/-20	◀	◀	◀	---	Pressure build-up (Fractionation 4)
SF51	1300	20/-50	◀	◀	◀	---	Flow-off (Fractionation 5)
SF52	1000	30/-30	◀	◀	◀	---	Evacuation (Fractionation 5)
SF53	1500	100/-20	◀	◀	◀	---	Pressure build-up (Fractionation 5)

Step	Universal B		Prion B	Gentle B	Quick B	Quick S	Program phase
	P [mbar _a]	Tolerance	Tolerance P/T				
SH11	2750	60/-60	◀	1770	◀	◀	Pressure build-up Supply
SH12	3031	60/-60	◀	2042	◀	◀	Pressure build-up Plateau
SS11	3059	60/-60	◀	2062	◀	◀	Preparation Sterilization
SS12	3166	60/-60	◀	2140	◀	◀	Sterilization
SA12	1200	60/-60	◀	◀	◀	◀	Pressure release

Key:

P = Pressure

T = Tolerance

◀ As in Universal B program

Empty chamber test

The coldest point in the sterilization chamber during the empty chamber test lies directly on the temperature sensor (see circular marking in the following figure). The temperature in the rest of the sterilization chamber is almost the same all over.

Schematic side and fore view of the sterilization chamber

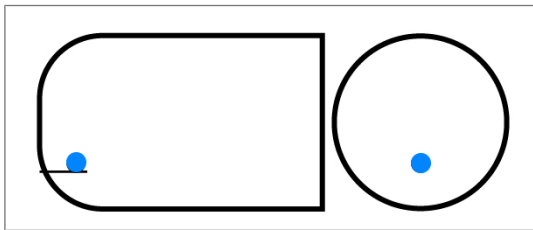

Pressure-time chart

Pressure-time diagram for Universal B, 134°C and 2.1 bar

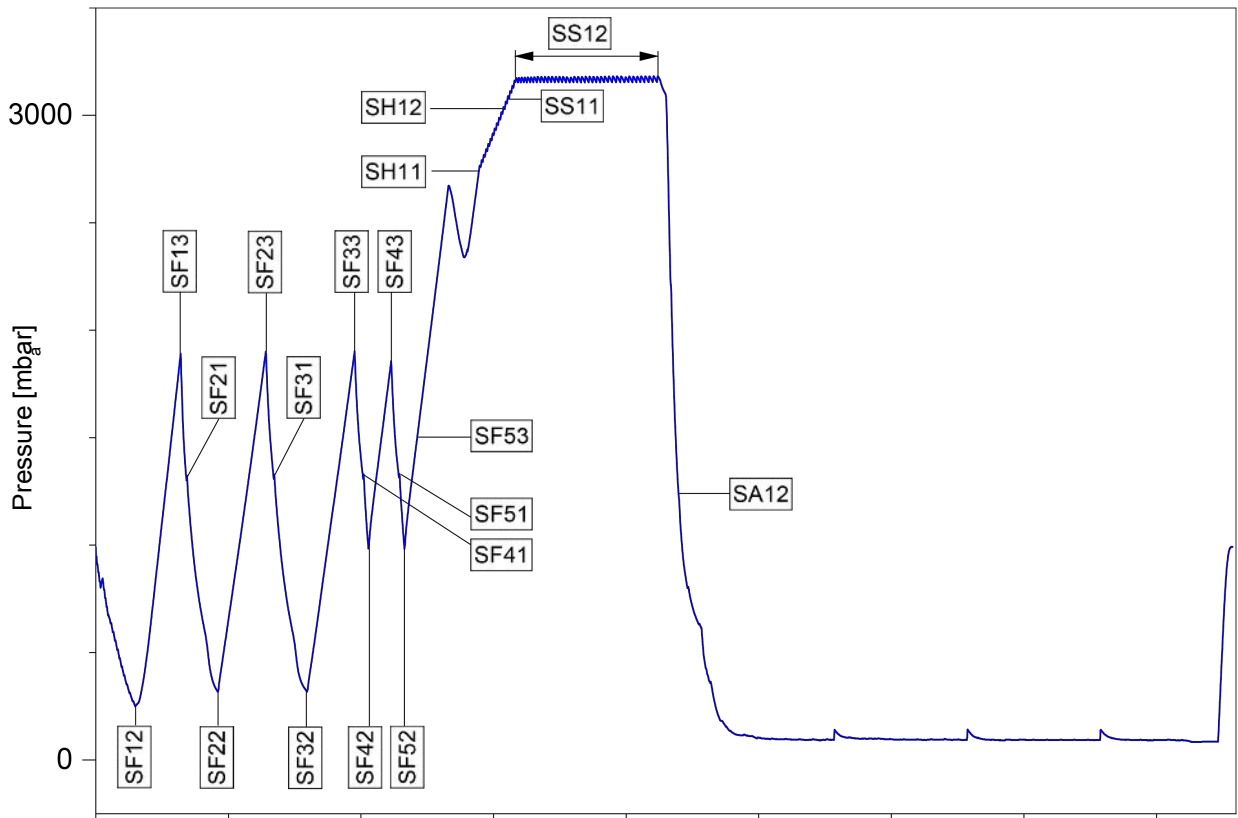

Glossary

Air leakage

is a location through which air can pass in and out without this being desired. Verification of the leakage serves to prove that the volume of air ingress in the chamber during the vacuum phase does not exceed a value which would prevent steam penetration of the sterilizer load and that the air leakage does not cause the possible contamination of the sterilizer load during the drying phase.

AKI

AKI is the abbreviation for "Arbeitskreis Instrumentenaufbereitung"

Authorised technician

An authorised technician is a person intensively trained and authorised by MELAG who has sufficient specific device and technical knowledge to perform maintenance and installation work on MELAG devices. Only they may carry out this work.

Batch

The batch is the composition of items which has been subject to the same reprocessing procedure.

Competent personnel

Trained personnel in accordance with national specifications for the respective area of application (dentistry, medicine, podiatry, veterinary medicine, cosmetics, piercing, tattoo) with the following contents: knowledge of instruments, hygiene and microbiology, risk assessment and classification of medical devices and instrument reprocessing.

Condensate

Fluid (e.g. water) produced by the cooling of and resultant separation from the vaporous state.

Conductivity

is the ability of a conductive chemical substance or mixture of substances to conduct or transfer energy or other substances or particles in space.

Corrosion

The chemical alteration or destruction of metal materials by water and chemicals

Delay in boiling

This refers to the phenomenon that it is possible under certain circumstances to heat a fluid beyond its boiling point without them boiling. This represents an unstable state; even low-level agitation can produce a large bubble within the shortest period, which expands explosively.

Demineralised water

Water without the minerals usually found in normal spring or tap water; is produced through ion exchange of normal tap water. It is used here as feed water.

DGSV

Abb.: "Deutsche Gesellschaft für Sterilgutverordnung" (German Association for the Sterilized Equipment Ordinance). The DGSV training centres are specified in DIN 58946, part 6 as "Requirements of personnel".

DGUV Regulation 1

DGUV is the abbreviation for "Deutsche Gesetzliche Unfallversicherung" (German Statutory Accident Insurance). The regulation 1 governs the principles of prevention.

DIN 58946-7

Standard – sterilization - steam steam sterilizers - part 7: Building requirements and requirements placed on the operating agents and the operation of steam sterilizers in the health-care branch

DIN 58953

Standard – sterilization, sterile equipment supply

Distilled water

From the Latin aqua destillata; also referred to as aqua dest; water which to a great extent is free from salts, organic material and micro-organisms, is produced from normal tap water or pre-cleaned water through the process of distillation (evaporation and subsequent condensation). Distilled water is used, for example, as feed water for steam sterilizers.

Dynamic pressure test of the sterilization chamber

Serves to prove that the rate of pressure variations during a sterilization cycle does not exceed a particular value which could result in the damage of the packaging material. [see EN 13060]

Empty chamber test

Test run without a load, performed to assess the performance of a sterilizer without the influence of a load; facilitating verification of the temperatures maintained in comparison to the temperatures set. [see EN 13060]

EN 13060

Standard – small steam sterilizers

EN 867-5

Standard – non-biological systems for use in sterilizers – part 5: The determination of indicator systems and test bodies for the performance inspection of type B and type S small sterilizers.

EN ISO 11140-1

Standard – the sterilization of products for use in medical treatment – chemical indicators – part 1: General requirements

EN ISO 11607-1

Standard - packaging for medical devices to be sterilized in the final packaging - Part 1: Requirements placed on materials, sterile barrier systems and packaging systems

Feed water

Feed water is required to produce steam for sterilization.
Guide values for water quality in accordance with EN 285 / EN 13060 – Appendix C

Load

Products, devices or materials that are reprocessed together in one operating cycle.

Mixed loads

wrapped and unwrapped load within a single batch

Multiple wrapping

e.g. wrapped instruments sealed in a double layer of film or wrapped in film and placed in an additional container or a container wrapped in textiles.

pH Value

The pH value is a measure of the strength of the acid or alkali effect of a watery solution.

Porous full load

Serves to prove that the values set on the control satisfy the necessary sterilization conditions in porous loads with a maximum mass for which the sterilizer is designed in accordance with EN 13060 [see EN 13060].

Porous partial load

Serves to prove that the values set on the control allow steam to enter the pre-determined test package quickly and equally [see EN 13060]

Process evaluation system

Also known as the self-monitoring system – this observes itself and compares the various sensors during a current program.

Product with narrow lumen

An article open on one side to which the following applies: $1 \leq L/D \leq 750$ and $L \leq 1500$ mm or an article with an opening on both sides which is: $2 \leq L/D \leq 1500$ and $L \leq 3000$ mm and which does not correspond to a hollow body article B; L...length of hollow body article; D...Diameter of hollow body article [see EN 13060]

Qualified electrician

Person with suitable technical training, knowledge and experience so that he or she can recognise and avoid hazards that can be caused by electricity [see IEC 60050 or for Germany VDE 0105-100].

RKI

Abbreviation for "Robert Koch Institute". It is one of the most important bodies for the safeguarding of public health in Germany.

Simple hollow bodies

An article open on one side to which the following applies: $1 \leq L/D \leq 5$ and $D \geq 5$ mm or an article with an opening on both sides which is: $2 \leq L/D \leq 10$ and $D \geq 5$ L...hollow body article length D... hollow body article diameter [see EN 13060]

Single wrapping

Wrapped once e.g. instruments sealed in foil – in opposition to: Multiple wrapping

Soft sterilization packaging

e.g. a paper bag or transparent sterilization packaging

Solid

Without hollows or gaps, solid, compact, closed

Solid load

Serves to prove that the necessary sterilization conditions have been reached within the entire load with the values set in the control. The load must represent the largest weight of massive instruments designed for sterilization in a sterilizer in accordance with EN 13060. [see EN 13060]

Sterile barrier system

A closed minimum packaging which prevents the entrance of micro-organisms e.g. through sealing bags, sealed and re-usable containers and folded sterilization towels etc.

Sterile material

Also referred to as a batch: a load which has already been sterilized, i.e. is sterile

Sterilization chamber

The interior of a sterilizer accommodates the load

Vacuum

In common parlance, an area devoid of all material. In the technical sense: volumes with a reduced gas pressure (at least air pressure)

Certificate of Suitability

According to the recommendations of the Commission for Hospital Hygiene and Infection Prevention at the Robert Koch Institute

Manufacturer:	MELAG Medizintechnik GmbH & Co. KG
Address:	Geneststraße 6-10 10829 Berlin
Country:	Germany
Product:	Vacuclave® 118/Vacuclave® 123
Type of device:	Steam sterilizer
Classification:	Class IIa
Device type acc. to EN 13060:	Type B

We declare that the product specified above is suitable for the steam sterilization of

- **Solid instruments (wrapped and unwrapped)**
- **Porous goods (wrapped and unwrapped)**
- **Instruments with narrow lumen (wrapped and unwrapped)**
- **Simple hollow bodies (wrapped and unwrapped)**

References to loading quantities and loading variations are outlined in the user manual and must be observed.

Be sure to observe the manufacturer's instructions for medical devices intended for sterilization according to EN ISO 17664.

We declare that the following test system is suited for testing the product specified above:

- **Helix test body according to EN 867-5:
MELAcontrol® and MELAcontrol® PRO**

Berlin, 01.03.2023

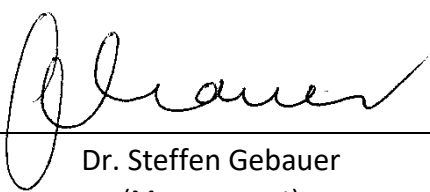

Dr. Steffen Gebauer
(Management)



[Order here!](#)  **PRAXISDIENST**
Medical Supplies since 1953

MELAG Medizintechnik GmbH & Co. KG

Geneststraße 6-10
10829 Berlin
Germany

Email: info@melag.com
Web: www.melag.com

Original instructions

Responsible for content: MELAG Medizintechnik GmbH & Co. KG
We reserve the right to technical alterations

Your stockist